

GATEMATE[®]
SUPERIOR GATE FURNITURE

SUPERIOR GATE FURNITURE

PRODUCT CATALOGUE



FENCEMATE[®]
SUPERIOR FENCING ACCESSORIES

SITEMATE[®]
SUPERIOR TOOLS AND FIXINGS

patura 

GATEMATE[®]
SUPERIOR GATE FURNITURE

...giving you the ability to fit your
doors, gates and fences, with
everything at your fingertips!

Discover one of the largest ranges of pre-packed door and gate furniture, supplied complete with all the screws and fixings you'll need.

- ✓ **Ideal for all your needs...** from simple bolts and hinges to complete gate kits, specialist fixings and ornamental ironmongery; there's genuinely something for every job!
- ✓ **Straightforward and convenient...** pre-packed complete with the right type and number of fixings, Gatemate door and gate furniture is easy to understand and easy to use.
- ✓ **Quality, reliability and durability, guaranteed...** the best materials, the best designs, the best manufacturing: we may offer competitive prices, but we don't compromise on quality.



GATEMATE®

Superior Gate Furniture



CONTENTS

- | | | |
|---|---|---------------------------------------|
| 5 Locks, Security and Handles | 46 Locking Bars and Hasp & Staples | 61 Metal Gates |
| 16 Field Gate Fittings | 47 Signs & Reflectors | 64 Shelf and Handrail Brackets |
| 26 Complete Gate Fixing Kits | 48 Premium Finish Range | 64 Chain, Wire & Rope Fittings |
| 27 Hinges | 54 Ornamental Range | 69 Trailer Fittings |
| 36 Latches, Catches, Hooks & Bolts | 58 High Performance Range | 70 Fencing Accessories |

FINISHES

There are a number of finishes available across all our ranges; offering different levels of corrosion resistance and a choice of price points.



SELF COLOUR

Unfinished steel. These products are typically used in fabrication, and will naturally rust very quickly – this should be removed prior to galvanisation.



EPOXY BLACK/EPOXY BROWN

Polyester powder coating is baked or sprayed onto the raw metal, resulting in a smooth finish. Provides limited corrosion resistance on moving parts as the finish can flake off, meaning the steel will corrode more easily.

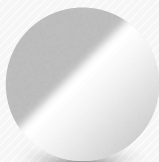

BZP

Also known as Zinc Plated. These products have been finished with a process of electroplating zinc onto steel, resulting in a shiny finish about 6-8 microns thick. Although zinc plated products are typically cheaper than galvanised ones, they usually rust more easily due to the thinner coating.

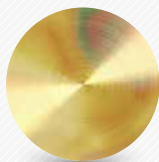

BZP/YP

Also known as BZP/Yellow Passivated. These products have a zinc plated finish with an additional yellow passivating treatment. This extra layer increases the corrosion resistance and gives the product a light yellow appearance.



PRE-GALVANISED

These products are fabricated from sheet steel that has already been galvanised, giving a finish approximately 20 microns thick. The resulting corrosion resistance is between that of hot-dip galvanising and zinc plating.



GALVANISED

A 'hot-dip' or 'spelter' galvanised finish approximately 60 microns thick. The product is dipped in molten zinc, resulting in a thick, rough coating that has a high corrosion resistance.



PREMIUM BLACK

A 'hot-dip' galvanised finish with a black polyester powder coating on top. This double layer results in a high level of corrosion resistance.



RUSPERT® GREEN/SILVER

Ruspert® is a rustproof treatment technology with superior corrosion resistance. An organic coating, containing aluminium flakes, and special rustproof paint passivates the metallic layer, preventing intrusion from corrosive factors and controlling the self-sacrificial galvanic effect of zinc.

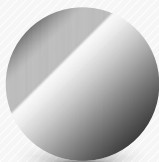

STAINLESS STEEL

Stainless steel is an iron alloy with high levels of chromium; giving it an external layer that is virtually rust free. Our premium range products are made from marine grade 316 stainless steel – ideal for coastal and other high-moisture environments.



CORROSION RESISTANCE

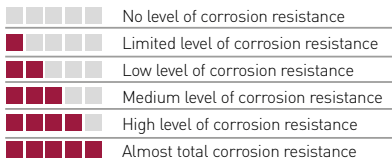

GATEMATE® LOCKS, SECURITY AND HANDLES

GATEMATE® Long Throw Locks

GATEMATE
Superior Gate Furniture

EURO PROFILE LONG THROW LOCK

High security stainless steel screws and driver bit included

Elongated anti-rattle keep with anti-chafe plate to prevent wear on the face of your post

High corrosion resistance; 316 stainless steel locking bolt

Narrowed body to allow installation at any height on stile; double thickness back plate

PATENT PENDING
07225GB AND 07256GB

High security 6 pin lock barrel; available to suit 50mm and 70mm gates

Polished stainless steel escutcheon plate

Comes with 5 keys as standard

Convenient, durable and reliable security by GATEMATE®

- Suitable for gates, sheds and garage doors
- Double or single sided locking options
- Yale profile key
- Can be keyed alike to any key number, enquire for more details!
- Keyed alike locks also available
- Comprehensive fitting instructions with self adhesive drilling template for easy installation
- The barrel can be changed
- Handles to suit available separately, see page 6



PREMIUM QUALITY

PRE PACKED

FIXINGS INCLUDED

GATEMATE® Euro Profile Long Throw Lock

- High security Euro Profile 6-pin barrel; allowing the flexibility to go to any approved key cutting company to duplicate keys
- High corrosion resistance; grade 316 stainless steel shoot bolt
- Elongated anti-rattle keep to prevent rattling during windy weather
- Unique bolt design with hardened steel core and chrome escutcheon plate
- Drill bits and stainless steel security screws included

LOCK TYPE	FINISH	SIZE INS (MM)	KEYED ALIKE	MIN. ORDER Qty	OUTER CARTON Qty	CODE
Double Locking (A)	Black/Stainless Steel	2 (50)	No	1	10	149 0086
Double Locking (A)	Black/Stainless Steel	2¾ (70)	No	1	10	149 0096
Single Locking (B)	Black/Stainless Steel	2 (50)	No	1	10	149 0106
Single Locking (B)	Black/Stainless Steel	2¾ (70)	No	1	10	149 0116

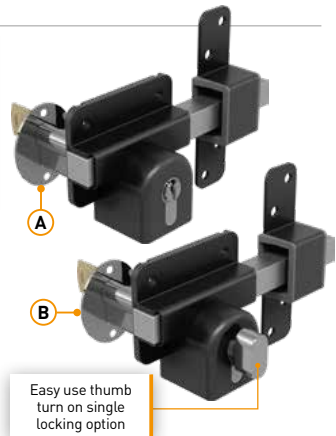

GATEMATE® Euro Profile Long Throw Lock - Keyed Alike

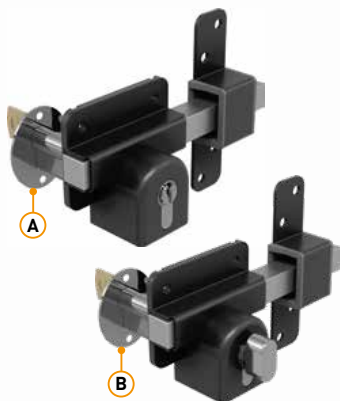

LOCK TYPE	FINISH	SIZE INS (MM)	KEYED ALIKE	MIN. ORDER Qty	OUTER CARTON Qty	CODE
Double Locking (A)	Black/Stainless Steel	2 (50)	Yes	1	10	149 0126
Double Locking (A)	Black/Stainless Steel	2¾ (70)	Yes	1	10	149 0136
Single Locking (B)	Black/Stainless Steel	2 (50)	Yes	1	10	149 0146
Single Locking (B)	Black/Stainless Steel	2¾ (70)	Yes	1	10	149 0156

GATEMATE® Pull Handle for Euro Profile Long Throw Lock



- Add the finishing touch to your Euro Profile Long Throw Locks with a pull handle
- Compatible with the GATEMATE® High Security Escutcheon (149003C)

FINISH	SIZE INS (MM)	MIN. ORDER Qty	INNER CARTON Qty	OUTER CARTON Qty	CODE
Epoxy Black	8 (200)	1	5	50	147 2013
Chrome	8 (200)	1	5	50	147 201C

GATEMATE® Escutcheon for Euro Profile Long Throw Lock



Escutcheon comes with Euro Profile Long Throw Lock as standard

FINISH	MIN. ORDER Qty	CODE
Polished stainless steel	1	149 001C

GATEMATE® High Security Escutcheon for Euro Profile Long Throw Lock

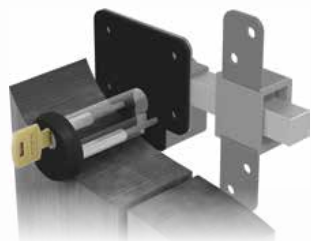

- Ensure the security of your GATEMATE® Euro Profile Long Throw Lock by installing this high security escutcheon.
- Anti-cut, anti-tamper and anti-drill, this escutcheon provides high intruder resistance.
- Clean, in-line design
- High corrosion resistance with a black finish

FINISH	MIN. ORDER Qty	OUTER CARTON Qty	CODE
Epoxy Black	1	12	149 003C

GATEMATE® Spare Parts for Euro Profile Long Throw Lock

DESCRIPTION	FINISH	SIZE (MM)	UNIT Qty	MIN. ORDER Qty	CODE
Blank Key (A)	Chrome		1	1	149 000C
Top Pin (B)	Brass	4.8 x 2.3	Pack of 100	1 Pack	149 P001
Top Pin (B)	Brass	5.3 x 2.3	Pack of 100	1 Pack	149 P002
Top Pin (B)	Brass	5.8 x 2.3	Pack of 100	1 Pack	149 P003
Top Pin (B)	Brass	6.3 x 2.3	Pack of 100	1 Pack	149 P004
Top Pin (B)	Brass	6.8 x 2.3	Pack of 100	1 Pack	149 P005
Top Pin (B)	Brass	7.3 x 2.3	Pack of 100	1 Pack	149 P006
Bottom Pin (C)	Brass	2.3	Pack of 100	1 Pack	149 BP01
Replacement Security Screws (D)	Stainless Steel		Pack of 8	1 Pack	149 0016
Spring (E)	Spring Steel		Pack of 100	1 Pack	149 S001
Grub Screw (F)	Black		Pack of 100	1 Pack	149 G001

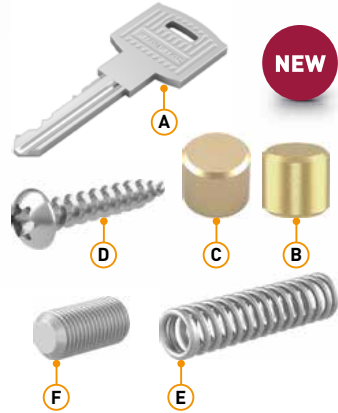

GATEMATE® Premium Long Throw Lock

- Quality long throw gate locks, available with single or double locking bolts and in two different barrel lengths
- 6 pin lock barrel
- Stainless steel shoot
- All locks supplied with 5 keys
- 28mm drill bit included
- Includes all fixings
- Locks available to suit 50mm or 70mm doors and gates

HANDLES TO SUIT AVAILABLE SEPARATELY, SEE PAGE 8

LOCK TYPE	FINISH	SIZE INS (MM)	KEYED ALIKE	MIN. ORDER Qty	OUTER CARTON Qty	CODE
Double Locking (A)	Stainless Steel/Black	2 (50)	No	1	20	149 0186
Double Locking (A)	Stainless Steel/Black	2½ (70)	No	1	20	149 0196
Single Locking (B)	Stainless Steel/Black	2 (50)	No	1	20	149 1106
Single Locking (B)	Stainless Steel/Black	2½ (70)	No	1	20	149 1116

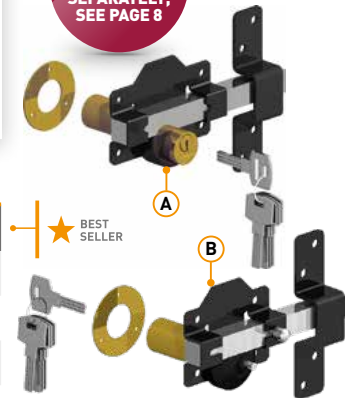

GATEMATE® Premium Long Throw Lock - Keyed Alike

LOCK TYPE	FINISH	SIZE INS (MM)	KEYED ALIKE	MIN. ORDER Qty	OUTER CARTON Qty	CODE
Double Locking (A)	Stainless Steel/Black	2 (50)	Yes	1	20	149 1126
Double Locking (A)	Stainless Steel/Black	2½ (70)	Yes	1	20	149 1136
Single Locking (B)	Stainless Steel/Black	2 (50)	Yes	1	20	149 1146
Single Locking (B)	Stainless Steel/Black	2½ (70)	Yes	1	20	149 1156

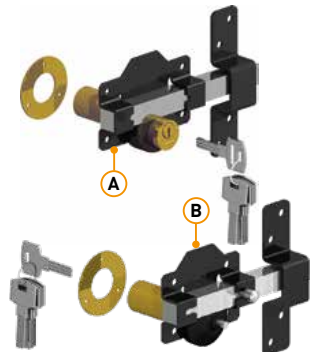

GATEMATE® Pull Handle for Premium Long Throw Lock



FINISH	SIZE INS (MM)	MIN. ORDER Qty	INNER CARTON Qty	OUTER CARTON Qty	CODE
Epoxy Black	8 (200)	1	5	50	147 2003
Brass	8 (200)	1	5	50	147 2005
Chrome	8 (200)	1	5	50	147 200C

GATEMATE® Security Escutcheon for Premium Long Throw Lock



- Super easy to fit, this escutcheon encloses the exposed part of the lock barrel, and bolts securely through the gate to a back plate that sits neatly behind the lock plate.
- High intruder resistance
- All fixings and fitting instructions included
- Anti-cut, anti-tamper and anti-drill
- Clean, in-line design

FINISH	MIN. ORDER Qty	CODE
Epoxy Black	1	149 0006

GATEMATE® Blank Key for Premium Long Throw Lock

Additional blank keys for the Premium Long Throw Lock



FINISH	MIN. ORDER Qty	OUTER CARTON Qty	CODE
Chrome	1	1000	149 0000

GATEMATE® Spade Drill for Long Throw Locks



SIZE (MM)	MIN. ORDER Qty	CODE
28	1	SPO 0280

GATEMATE® Gate Handles

GATEMATE® Cast Door-Gate Pull Handles



FINISH	SIZE INS (MM)	MIN. ORDER Qty	CODE
Galvanised	6 (150)	5	537 1501
Epoxy Black	6 (150)	5	537 1503

GATEMATE® Pressed Steel Pull Handle



FINISH	SIZE INS (MM)	MIN. ORDER Qty	CODE
BZP	7 (175)	5	547 1752
Epoxy Black	7 (175)	5	547 1753

GATEMATE® Zedlocks®

GATEMATE®
Superior Gate Furniture

ZEDLOCK® LONG THROW LOCK

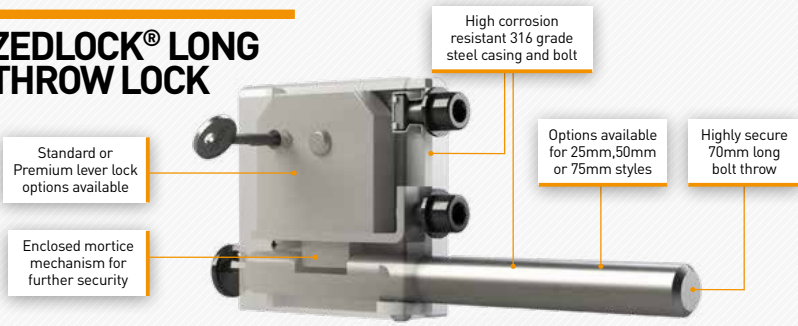

Designed in the UK, the GATEMATE® Zedlock® is a unique, premium quality, patented long throw lock; ideal for securing any large gate and a great replacement for a padlock and chain

- Options for wooden field gates or steel security gates
- Highly durable; minimal moving parts mean it will work in freezing conditions
- Highly secure tamper-proof design with Sold Secure Bronze status
- Stainless steel, galvanised and epoxy black finishes
- All Zedlocks come with two keys



GATEMATE® Zedlock® Long Throw Lock (Suitable for Metal Field Gates and Security Gates)

- Designed in the UK, the GATEMATE® Zedlock® is a unique, premium quality, patented long throw lock; ideal for securing any large gate and a great replacement for a padlock and chain
- 4" (100mm) lock body with 2¾" (70mm) throw



FINISH	SUITABLE FOR	KEYED ALIKE	LEVER MECHANISM	MIN. ORDER Qty	OUTER CARTON Qty	CODE
Galvanised	1" (25mm) stiles	No	Standard (3 lever)	1	12	890 0001
Galvanised	2" (50mm) stiles	No	Standard (3 lever)	1	12	890 0501
Stainless Steel	1" (25mm) stiles	No	Standard (3 lever)	1	12	890 0006
Stainless Steel	1" (25mm) stiles	No	Premium (Union 5 lever)	1	12	890 0016
Stainless Steel	2" (50mm) stiles	No	Standard (3 lever)	1	12	890 0506
Stainless Steel	2" (50mm) stiles	No	Premium (Union 5 lever)	1	12	890 0516

GATEMATE® Zedlock® Long Throw Lock (Suitable for Metal Field Gates and Security Gates) - Keyed Alike

4" (100mm) lock body with 2¾" (70mm) throw



FINISH	SUITABLE FOR	KEYED ALIKE	LEVER MECHANISM	MIN. ORDER Qty	OUTER CARTON Qty	CODE
Galvanised	1" (25mm) stiles	Yes	Standard (3 lever)	1	12	890 0001KA
Galvanised	2" (50mm) stiles	Yes	Standard (3 lever)	1	12	890 0501KA
Stainless Steel	1" (25mm) stiles	Yes	Standard (3 lever)	1	12	890 0006KA
Stainless Steel	1" (25mm) stiles	Yes	Premium (Union 5 lever)	1	12	890 0016KA
Stainless Steel	2" (50mm) stiles	Yes	Standard (3 lever)	1	12	890 0506KA
Stainless Steel	2" (50mm) stiles	Yes	Premium (Union 5 lever)	1	12	890 0516KA

GATEMATE® Zedlock® Long Throw Lock (Suitable for Wooden Field Gates)

4" (100mm) lock body with 2¾" (70mm) throw



FINISH	SUITABLE FOR	KEYED ALIKE	LEVER MECHANISM	MIN. ORDER Qty	OUTER CARTON Qty	CODE
Premium Black Steel	3" (75mm) stiles	No	Standard (3 lever)	1	12	890 0011
Epoxy Black on Stainless Steel	3" (75mm) stiles	No	Premium (Union 5 lever)	1	12	890 0116

GATEMATE® Zedlock® Long Throw Lock (Suitable for Wooden Field Gates) - Keyed Alike

4" (100mm) lock body with 2¾" (70mm) throw



FINISH	SUITABLE FOR	KEYED ALIKE	LEVER MECHANISM	MIN. ORDER Qty	OUTER CARTON Qty	CODE
Premium Black Steel	3" (75mm) stiles	Yes	Standard (3 lever)	1	12	890 0011KA
Epoxy Black on Stainless Steel	3" (75mm) stiles	Yes	Premium (Union 5 lever)	1	12	890 0116KA

GATEMATE® Zedlock® Multi-Lever Key Blanks

UNIT Qty	MIN. ORDER Qty	CODE
Pack of 5	1 Pack	890 0992



GATEMATE® Zedlock Extension Handle

Use to increase the handle length on your Zedlock®; easily screws on to the existing handle.



FINISH	SIZE INS (MM)	MIN. ORDER Qty	CODE
BZP	2 (50)	1	891 0501

GATEMATE® Zedlock® Morticed Striker

Galvanised steel morticed striker plate designed for use with all the Zedlocks® in the range. Can be screwed to masonry or wood alike.

FINISH	SIZE INS (MM)	MIN. ORDER Qty	CODE
Galvanised	2 x 9 x 1/4 [50 x 230 x 6]	1	893 0011



GATEMATE® Zedlock® Hole Cutter (for Metal Gates)

SIZE (MM)	MIN. ORDER Qty	CODE
22	1	894 0000



GATEMATE® Zedlock® Double Gate Drop Bolt

Designed for securing double gates in the middle, this kit is perfect for double gated residential driveways. To suit metal and wooden gates.

FINISH	MIN. ORDER Qty	CODE
Galvanised	1	894 0011
Black	1	894 0016



GATEMATE® Zedlock® Gate Claw (for Metal Gates)

FINISH	SUITABLE FOR	MIN. ORDER Qty	CODE
Galvanised	25mm stiles (double gates)	1	894 0021
Galvanised	50mm stiles (double gates)	1	894 0051
Galvanised	50mm stiles (single gates)	1	894 0151
Galvanised	60mm stiles (single gates)	1	894 0161

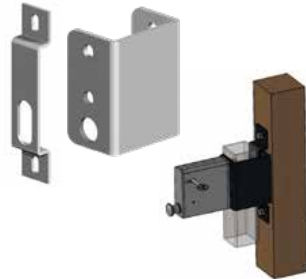

GATEMATE® Zedlock® Surface Mounting Kit

Designed for use with solid gates; this Surface Mounting Kit allows locks to be mounted on the surface of the gate. Compatible with all Zedlock models.

FINISH	SIZE INS (MM)	MIN. ORDER Qty	OUTER CARTON Qty	CODE
Galvanised	4 (100)	1	12	895 0001



GATEMATE® Zedlock® Surface Mounted Keep

Galvanised steel bolt-on surface mounted keep.

FINISH	SIZE (MM)	MIN. ORDER Qty	CODE
Galvanised	3 (75)	1	895 0011



GATEMATE® Padlocks & Utility Locks

GATEMATE®
Superior Gate Furniture

BRASS PADLOCK

Our brass padlocks are manufactured from premium quality materials to ensure a high level of security. Also available with a long shackle.

- Supplied with 3 keys
- High precision machined pins
- Available in single, double and quadruple pack quantities
- Keyed alike options also available



GATEMATE® Brass Padlock

FINISH	SIZE INS (MM)	KEYED ALIKE	UNIT Qty	MIN. ORDER Qty	CODE
Brass	1¼ (30)	No	Pack of 1	5	148 0300
Brass	1½ (40)	No	Pack of 1	5	148 0400
Brass	2 (50)	No	Pack of 1	5	148 0500
Brass	2½ (60)	No	Pack of 1	5	148 0600
Brass	3 (70)	No	Pack of 1	5	148 0700
Brass	1½ (40)	Yes	Pack of 2	5	148 2400
Brass	2 (50)	Yes	Pack of 2	5	148 2500
Brass	1½ (40)	Yes	Pack of 4	5	148 4400
Brass	2 (50)	Yes	Pack of 4	5	148 4500

With hardened shackle

GATEMATE® Brass Padlock with Long Shackle

FINISH	SIZE INS (MM)	KEYED ALIKE	MIN. ORDER Qty	CODE
Brass	1½ (40)	No	5	148 0410
Brass	2 (50)	No	5	148 0510

With hardened shackle



GATEMATE® Heavy Duty Armoured Block Padlock

FINISH	SIZE INS (MM)	KEYED ALIKE	UNIT Qty	MIN. ORDER Qty	CODE
Stainless Steel/ Nickel Plated	2½ (60)	No	Pack of 1	5 Packs	708 0600
Stainless Steel/ Nickel Plated	2¾(70)	No	Pack of 1	5 Packs	708 0700
Stainless Steel/ Nickel Plated	3¼ (80)	No	Pack of 1	5 Packs	708 0800
Stainless Steel/ Nickel Plated	3½ (90)	No	Pack of 1	5 Packs	708 0900
Stainless Steel/ Nickel Plated	2¾(70)	Yes	Pack of 2	5 Packs	708 2700
Stainless Steel/ Nickel Plated	3¼ (80)	Yes	Pack of 2	1 Pack	708 2800



GATEMATE® Laminated Steel Padlock

FINISH	SIZE INS (MM)	KEYED ALIKE	UNIT Qty	MIN. ORDER Qty	CODE
Laminated Steel	1¼ (30)	No	Pack of 1	5	713 0300
Laminated Steel	1½ (40)	No	Pack of 1	5	713 0400
Laminated Steel	2 (50)	No	Pack of 1	5	713 0500
Laminated Steel	2½ (60)	No	Pack of 1	5	713 0600
Laminated Steel	1½ (40)	Yes	Pack of 2	5	713 2400
Laminated Steel	2 (50)	Yes	Pack of 2	5	713 2500
Laminated Steel	1½ (40)	Yes	Pack of 4	5	713 4400
Laminated Steel	2 (50)	Yes	Pack of 4	5	713 4500

With hardened shackle



GATEMATE® Laminated Steel Padlock with Long Shackle

FINISH	SIZE INS (MM)	KEYED ALIKE	MIN. ORDER Qty	CODE
Laminated Steel	1½ (40)	No	5	713 0410
Laminated Steel	2 (50)	No	5	713 0510

With hardened shackle



GATEMATE® Discus Padlock

FINISH	SIZE INS (MM)	KEYED ALIKE	UNIT Qty	MIN. ORDER Qty	CODE
Stainless Steel*	2¾ (70)	No	Pack of 1	5	771 0700
Stainless Steel*	2¾ (70)	Yes	Pack of 2	5	771 2700

*Constructed from 316 stainless steel



GATEMATE®
Superior Gate Furniture

PADLOCK PROTECTORS

- This simple hasp and staple provides extra security from intruders
- Constructed from heavy duty galvanised steel
- Recommended padlocks:
GATEMATE® Discus Padlocks
GATEMATE® Brass Padlocks

Available in both left and right hand orientations

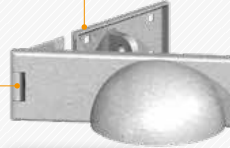

Unique design to prevent pin from being drilled or removed

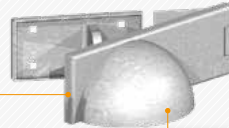

When the product is locked, access to the padlock is limited by the domed cover and the padlock is protected from the weather making it last longer!

PREMIUM QUALITY

PRE PACKED

FIXINGS INCLUDED

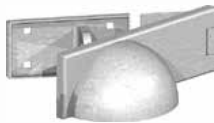

GATEMATE® Padlock Protector

FINISH	SIZE INS (MM)	DESC	MIN. ORDER Qty	CODE
Galvanised	7½ x 2½ (185 x 60)	Left Handed	1	144 1851
Galvanised	7½ x 2½ (185 x 60)	Right Handed	1	144 1861

Recommended padlocks:

Discus padlocks: 70mm (7710700)

Close shackle padlocks: 50mm (7070650) and 70mm (7070700)

Brass padlocks: 40mm (1480400), 50mm (1480500) and 60mm (1480600)

GATEMATE® Padlock Eyes



FINISH	SIZE INS (MM)	UNIT Qty	MIN. ORDER Qty	OUTER CARTON Qty	CODE
Stainless Steel/Black	2 (50)	Pack of 2	1 Pair	5 Pair	149 0513

GATEMATE® Shed Security Bar



FINISH	LENGTH (M)	MIN. ORDER Qty	CODE
Galvanised	1.0	1	139 1001
Galvanised	1.8	1	139 1801

GATEMATE® Rimsashlocks

GATEMATE® Rimsashlock - 2 Lever

FINISH	SIZE INS (MM)	MIN. ORDER Qty	CODE
Epoxy Black	6 x 4 (150 x 100)	5	540 0010



GATEMATE® Cast Ball Door Knob

FINISH	SIZE INS (MM)	SPINDLE LENGTH INS (MM)	MIN. ORDER Qty	OUTER CARTON Qty	CODE
Dull Black	1 3/4 (45)	3 (75)	1	5	575 0453



GATEMATE® Cast Oval Door Knob

FINISH	SIZE INS (MM)	SPINDLE LENGTH INS (MM)	MIN. ORDER Qty	OUTER CARTON Qty	CODE
Dull Black	2 (50)	3 (75)	1	5	575 0603



GATEMATE® Rimsashlock Door Knob

FINISH	SIZE INS (MM)	MIN. ORDER Qty	CODE
Black Plastic	2 (50)	5	540 0020



GATEMATE® FIELD GATE FITTINGS

GATEMATE® Field Gate Hinges

GATEMATE®
Superior Gate Furniture

FIELDGATE DOUBLE STRAP HINGE SETS

- Heaviest field gate sets on the market!
- Hot dip galvanised fixings included

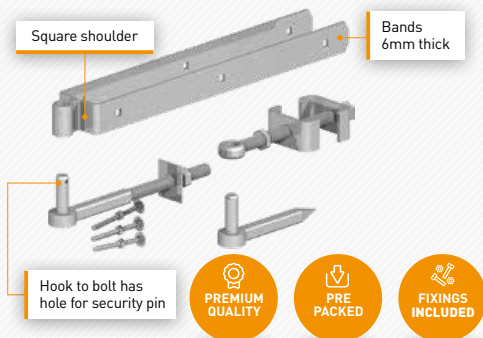

GATEMATE®
Superior Gate Furniture

HINGE LOADING APPLICATION PER PAIR

When selecting hinges for your gate please ensure that you choose ones with the correct loading application.

This is only approximate hinge loading application as none of our hinges are tested.

For heavier gates an additional hinge can be added.

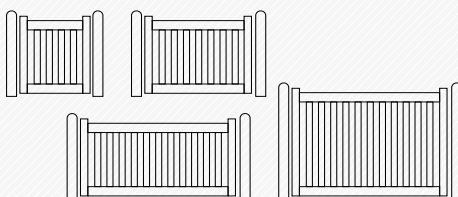

GATE TYPE	CLASS	WEIGHT	MAXIMUM WIDTH
A	SMALL GATES AND DOORS	UP TO 10KG	900MM
B	MEDIUM GATE	UP TO 20KG	1200MM
C	LARGE GATE	UP TO 50KG	1800MM
D	EXTRA LARGE GATE	UP TO 80KG	2400MM

GATEMATE® Field Gate Double Strap Hinge Set

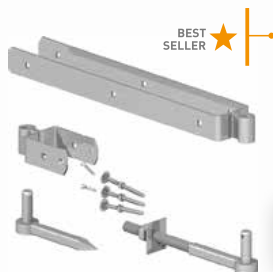

FINISH	SIZE INS (MM)	SUITABLE FOR	HOOK TO BOLT SIZE (INS)	LOAD APPL.	MIN. ORDER Qty	OUTER CARTON Qty	PALLET Qty	CODE
Galvanised	12 (300)	3" gates	13"	D	1	4	120	030 3001
Galvanised	18 (450)	3" gates	13"	D	1	4	120	030 4501
Galvanised	24 (600)	3" gates	13"	D	1	4	120	030 6001
Galvanised	24 (600)	3" gates	11"	D	1	4	120	030 6011
Epoxy Black	12 (300)	3" gates	13"	D	1	4	120	030 3003
Epoxy Black	18 (450)	3" gates	13"	D	1	4	120	030 4503
Epoxy Black	24 (600)	3" gates	13"	D	1	4	120	030 6003
Premium Black	24 (600)	3" gates	13"	D	1	4	-	030 6008

Includes: 2" x 1/4" top band, 5" x 2" x 1/4" bottom band, hook to bolt, hook to drive and fixings.

GATEMATE® Field Gate Double Strap Hinge Set with Adjustable Hook on Plate

FINISH	SIZE INS (MM)	SUITABLE FOR	LOAD APPL.	MIN. ORDER Qty	OUTER CARTON Qty	PALLET Qty	CODE
Galvanised	18 (450)	3" gates	D	1	4	120	030 4521
Galvanised	24 (600)	3" gates	D	1	4	120	030 6521

Includes: 2" x 1/4" top band, 5" x 2" x 1/4" bottom band, 2 x adjustable hooks on 4" square plates with 3/4" diameter pin and fixings.



GATEMATE® Field Gate Double Strap Hinge Set with Gate Hanger to Bolt

FINISH	SIZE INS (MM)	SUITABLE FOR	LOAD APPL.	MIN. ORDER Qty	OUTER CARTON Qty	PALLET Qty	CODE
Galvanised	24 (600)	3" gates	D	1	4	120	030 6021

Includes: 2" x 1/4" top band, 5" x 2" x 1/4" bottom band, 14" gate hanger to bolt, hook to drive and fixings.

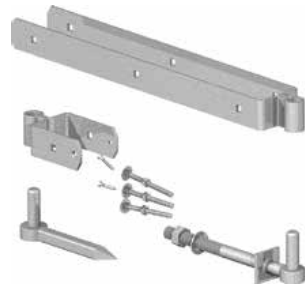

GATEMATE® Field Gate Double Strap Hinge Set with Hooks on Plates

FINISH	SIZE INS (MM)	SUITABLE FOR	LOAD APPL.	MIN. ORDER Qty	OUTER CARTON Qty	PALLET Qty	CODE
Galvanised	12 (300)	3" gates	D	1	4	120	031 3001
Galvanised	18 (450)	3" gates	D	1	4	120	031 4501
Galvanised	24 (600)	3" gates	D	1	4	120	031 6001

Includes: 2" x 1/4" top band, 5" x 2" x 1/4" bottom band, 2 x hooks on 4" square plates and fixings.

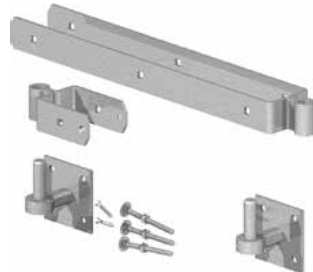

FENCEMATE® DuraPost®

**STRONGER
LIGHTER
FASTER**

**OUR NEW COLD ROLLED
STEEL FENCEPOST**

**HAVE YOU
SEEN OUR
OTHER
RANGES?**



GATEMATE® Field Gate Adjustable Double Strap Hinge Set

Full adjustability allows installer to easily fit and adjust gates to compensate for gate drop over time.

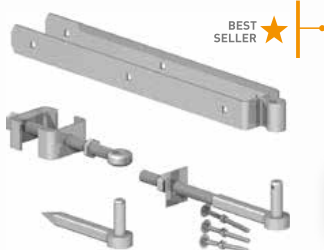

FINISH	SIZE INS (MM)	SUITABLE FOR	LOAD APPL.	MIN. ORDER Qty	OUTER CARTON Qty	PALLET Qty	CODE
Galvanised	12 (300)	3" gates	D	1	4	120	033 3001
Galvanised	18 (450)	3" gates	D	1	4	120	033 4501
Galvanised	24 (600)	3" gates	D	1	4	120	033 6001
Epoxy Black	12 (300)	3" gates	D	1	4	120	033 3003
Epoxy Black	18 (450)	3" gates	D	1	4	120	033 4503
Epoxy Black	24 (600)	3" gates	D	1	4	120	033 6003
Premium Black	24 (600)	3" gates	D	1	4	-	033 600B

Includes: 2" x 1/4" top band, adjustable gate eye and heel clips, hook to bolt, hook to drive and fixings.

GATEMATE® Field Gate Adjustable Double Strap Hinge Set with Hooks on Plates



FINISH	SIZE INS (MM)	SUITABLE FOR	LOAD APPL.	MIN. ORDER Qty	OUTER CARTON Qty	PALLET Qty	CODE
Galvanised	12 (300)	3" gates	D	1	4	120	033 3001
Galvanised	18 (450)	3" gates	D	1	4	120	033 4501
Galvanised	24 (600)	3" gates	D	1	4	120	033 6001
Epoxy Black	24 (600)	3" gates	D	1	4	120	033 6003

Includes: 2" x 1/4" top band, adjustable gate eye and heel clips, 2 x hooks on 4" square plates and fixings.

GATEMATE® Field Gate Self-Closing/Rising 45° Hinge Set

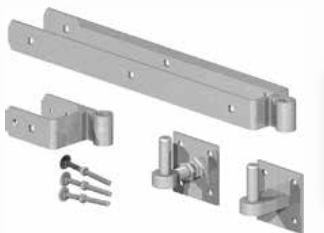

FINISH	SIZE INS (MM)	SUITABLE FOR	LOAD APPL.	MIN. ORDER Qty	OUTER CARTON Qty	PALLET Qty	CODE
Galvanised	18 (450)	3" gates	D	1	4	120	034 4511

Includes: 18" top band with 1" diameter eye, 5" bottom band with offset eye on corner, hook on 4" square plate, 3/4" diameter adjustable hook on 4" square plate and fixings. (Gate to be hung between posts). See fitting instructions overleaf!

GATEMATE® Field Gate Self-Closing/Rising 90° Hinge Set

FINISH	SIZE INS (MM)	SUITABLE FOR	LOAD APPL.	MIN. ORDER Qty	OUTER CARTON Qty	PALLET Qty	CODE
Galvanised	24 (600)	3" gates	D	1	4	84	034 6011

Includes: 24" top band with 1" straight eye on corner, adjustable gate eye and heel clips, hook on 4" square plate, 3/4" diameter adjustable hook on 4" square plate and fixings. (Gate to be hung on rear of posts)



GATEMATE® Field Gate Self-Closing/Rising 180° Hinge Set (2 Way)

FINISH	SIZE INS (MM)	SUITABLE FOR	LOAD APPL.	MIN. ORDER Qty	OUTER CARTON Qty	PALLET Qty	CODE
Galvanised	24 (600)	3" gates	D	1	2	70	034 6021

Includes: 24" top band with 1" diameter eye, bottom band with rocker plate, 15" lock through hook with 3/4" diameter pin and fixings. When gate is open at 90 degrees to post, approximate rise is 75mm per metre width of gate. (Gate to be hung between posts)



GATEMATE® Field Gate Rising Hinge Set with Rocker Plate

FINISH	SIZE INS (MM)	SUITABLE FOR	LOAD APPL.	MIN. ORDER Qty	OUTER CARTON Qty	PALLET Qty	CODE
Galvanised	24 (600)	3" gates	D	1	4	120	034 6001

Includes: 2" x 1/4" top band, hook to bolt, bottom band with rocker plate and fixings. When gate is open at 90 degree to post, approximate rise is 75mm per metre width of gate. (Gate to be hung between posts)

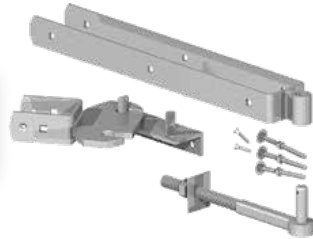

SITEMATE®
Superior Tools and Fixings



**ASK YOUR STOCKIST
FOR FURTHER DETAILS**

GATEMATE® Field Gate Fasteners

GATEMATE® Double Field Gate Fastener Set with Garage Door Bolt

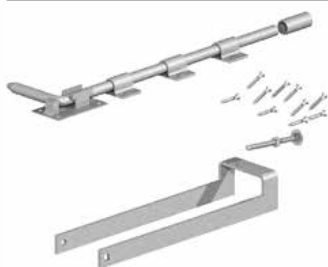

DESC	FINISH	SUITABLE FOR	MIN. ORDER Qty	OUTER CARTON Qty	CODE
18" Garage Door Bolt	Galvanised	3" gates	1	10	038 0001
24" Garage Door Bolt	Galvanised	3" gates	1	10	038 0011
18" Garage Door Bolt	Premium Black	3" gates	1	10	038 000B

Includes: garage door bolt, 14" throwover loop and fixings.

GATEMATE® Double Field Gate Fastener Set with 2 Garage Door Bolts

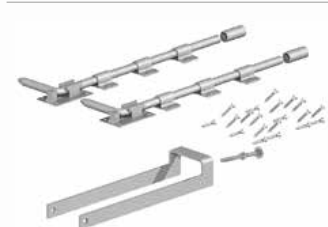

FINISH	SUITABLE FOR	MIN. ORDER Qty	OUTER CARTON Qty	CODE
Galvanised	3" gates	1	10	038 0021

Includes: 2 x 18" garage door bolts, 14" throwover loop and fixings.

GATEMATE® Field Gate Spring Fastener Set with Staple Catch

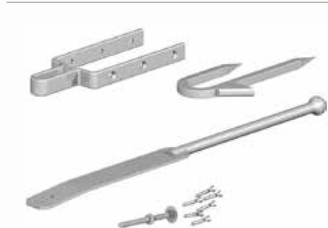

FINISH	SIZE INS (MM)	MIN. ORDER Qty	OUTER CARTON Qty	CODE
Galvanised	24 (600)	1	10	036 0001
Epoxy Black	24 (600)	1	10	036 0003
Premium Black	24 (600)	1	10	036 000B

Includes: spring fastener, staple catch, keep and fixings.

GATEMATE® Field Gate Spring Fastener Set with Central Closing Catch



FINISH	SIZE INS (MM)	MIN. ORDER Qty	OUTER CARTON Qty	CODE
Galvanised	24 (600)	1	10	037 0011

Includes: spring fastener, central closing gate catch, keep and fixings.

GATEMATE® Field Gate Spring Fastener Set with Drive Catch

FINISH	SIZE INS (MM)	MIN. ORDER Qty	OUTER CARTON Qty	CODE
Galvanised	26 (600)	1	10	037 0001

Includes: spring fastener, drive catch, keep and fixings.

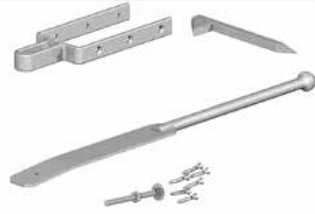

GATEMATE® Field Gate New Zealand Fasteners

FINISH	SIZE (MM)	MIN. ORDER Qty	CODE
BZP	1000	5	571 1002
BZP	420	5	571 4202



GATEMATE® Field Gate Northumberland Fastener

FINISH	SIZE INS (MM)	MIN. ORDER Qty	CODE
Galvanised	16 (400)	5	571 3001



GATEMATE® Field Gate Latches, Catches & Bolts

GATEMATE® Field Gate Self-Locking Catch Kit with Cranked Striker

FINISH	PACK TYPE	MIN. ORDER Qty	OUTER CARTON Qty	CODE
Galvanised	Bag	5	-	563 0001
Galvanised	Plain Box	1	20	039 0001



GATEMATE® Field Gate Self Locking Catch Kit with Double Leg Striker

FINISH	PACK TYPE	MIN. ORDER Qty	OUTER CARTON Qty	CODE
Galvanised	Plain Box	1	10	039 0011



GATEMATE®
Superior Gate Furniture

FIELD GATE SELF LOCKING ANIMAL SAFETY CATCH KIT

- Designed to provide maximum safety for animals and prevent livestock from injury
- Hot dip galvanised fixings included

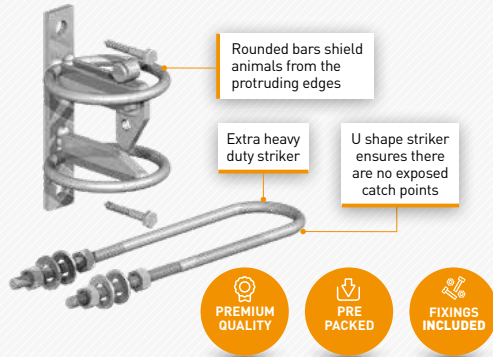

GATEMATE® Field Gate Animal Safety Self Locking Catch Kit with Double Leg Striker



FINISH	PACK TYPE	CODE
Galvanised	Plain Box	039 0041

GATEMATE® Field Gate Hunting Type Locking Catch Kit



FINISH	MIN. ORDER Qty	CODE
Galvanised	5	564 0001

FIELD GATE HUNTING TYPE LIFT CATCH KIT

- Ergonomically designed for horse riders – allowing operation of a gate without the need to dismount
- Manufactured from heavy duty galvanised steel
- Blunt edges to ensure no harm to animals
- Reliable latching system
- Hot dip galvanised fixings included

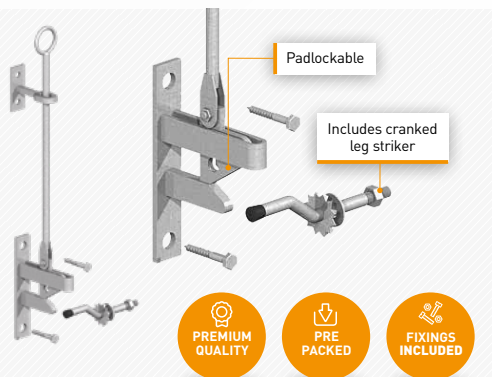

GATEMATE® Field Gate Hunting Type Lift Catch Kit

FINISH	MIN. ORDER Qty	OUTER CARTON Qty	CODE
Galvanised	1	10	039 0031



GATEMATE® Field Gate Central Closing Catch

FINISH	MIN. ORDER Qty	CODE
Galvanised	5	568 0001



GATEMATE® Field Gate Shoot Bolt

FINISH	MIN. ORDER Qty	CODE
Galvanised	5	566 0001



GATEMATE® Field Gate Accessories



GATEMATE® Field Gate 'D' Bracket

FINISH	SIZE INS (MM)	MIN. ORDER Qty	CODE
Galvanised	3½ (89)	5	578 0801



GATEMATE® Field Gate Slip Rail Bracket

Heavy duty material; 4mm thick. Includes galvanised coach screws.

FINISH	SIZE INS (MM)	SUITABLE FOR	MIN. ORDER Qty	OUTER CARTON Qty	CODE
Galvanised	4x2 (100x50)	up to 2 x 4" rails	5	20	529 0001



GATEMATE® Field Gate Rail Brackets

FINISH	SIZE INS (MM)	UNIT Qty	MIN. ORDER Qty	CODE
Galvanised	2 (50)	Pack of 2	5	583 0511



GATEMATE® Field Gate Staples

FINISH	SIZE INS (MM)	UNIT Qty	MIN. ORDER Qty	CODE
Galvanised	3 (75)	Pack of 5	5	577 0751
Galvanised	4 (100)	Pack of 5	5	577 1001
Galvanised	6 (150)	Pack of 5	5	577 1501



GATEMATE® Field Gate Staple to Drive

FINISH	SIZE INS (MM)	MIN. ORDER Qty	CODE
Galvanised	4 (100)	5	579 1001

GATEMATE® Field Gate Staple on Elongated Plate

FINISH	SIZE INS (MM)	MIN. ORDER Qty	CODE
Galvanised	3 (75)	5	578 0751



GATEMATE® Adjustable Gate Eye with 2 Nuts

FINISH	THREAD LENGTH X PIN Ø INS (MM)	SHANK DIA (MM)	UNIT Qty	MIN. ORDER Qty	CODE
Galvanised	6x1 (150x25)	25	Pack of 2	5 Packs	549 6251
Galvanised	8x1¼ (200x32)	30	Pack of 2	5 Packs	549 8321
BZP	4x½ (100x12)	12	Pack of 2	5 Packs	549 4122
BZP	4x¾ (100x16)	16	Pack of 2	5 Packs	549 4162
BZP	4x¾ (100x20)	20	Pack of 2	5 Packs	549 4202
BZP	6x½ (150x12)	12	Pack of 2	5 Packs	549 6122
BZP	6x¾ (150x16)	16	Pack of 2	5 Packs	549 6162
BZP	6x¾ (150x20)	20	Pack of 2	5 Packs	549 6202
BZP	8x¾ (200x20)	20	Pack of 2	5 Packs	549 8202



GATEMATE® Field Gate Safety Hook & Eye

FINISH	SIZE INS (MM)	MIN. ORDER Qty	CODE
Galvanised	6 (150)	5	528 1501

Includes chain and eyes



GATEMATE® Field Gate Throwover Loop

FINISH	SIZE INS (MM)	SUITABLE FOR	MIN. ORDER Qty	CODE
Galvanised	14 (350)	3" gates	5	560 3501



GATEMATE® Field Gate Spring Loaded Wheel - Medium Duty

FINISH	SIZE INS (MM)	MIN. ORDER Qty	OUTER CARTON Qty	CODE
BZP	11 (280)	1	5	581 2802



GATEMATE® COMPLETE GATE FIXING KITS

GATEMATE®
Superior Gate Furniture

COMPLETE GATE FIXING KITS

Our Fixing Kits contain everything needed to fit your gate; hinges, catches, fixings and instructions.

- Available with suffolk latches, ring gate latches or auto gate catches
- Ruspert high performance woodscrews included

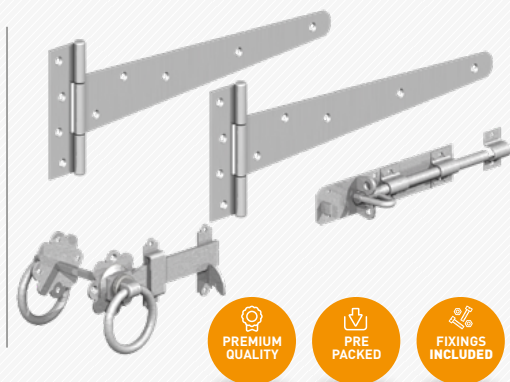

GATEMATE® Pedestrian Gate Kit with Auto Catch

FINISH	MIN. ORDER Qty	CODE
Galvanised	5	595 0001
BZP	5	595 0002
Epoxy Black	5	595 0003

Includes: 1 x pair 14" medium tee hinges, 1 x medium auto catch and fixings to suit.



GATEMATE® Side Gate Kit with Ring Gate Latch

FINISH	TEE HINGE SIZE (INS)	MIN. ORDER Qty	PALLET Qty	CODE
Galvanised	16"	5	-	596 0111
Galvanised	18"	5	250	596 0001
BZP	18"	5	250	596 0002
Epoxy Black	16"	5	-	596 0113
Epoxy Black	18"	5	250	596 0003

Includes: 1 x pair 16" or 18" medium tee hinges, 1 x 6" ring gate latch, 1 x 6" x 1/2" brenton padbolt and fixings to suit.

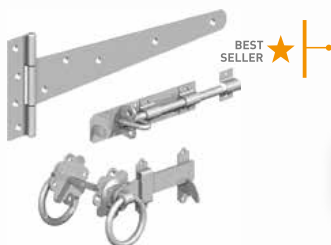

GATEMATE® Side Gate Kit with Heavy Suffolk Latch

FINISH	TEE HINGE SIZE (INS)	MIN. ORDER Qty	PALLET Qty	CODE
Galvanised	16"	5	-	597 0111
Galvanised	18"	5	250	597 0001
BZP	18"	5	250	597 0002
Epoxy Black	16"	5	-	597 0113
Epoxy Black	18"	5	250	597 0003

Includes: 1 x pair 16" or 18" medium tee hinges, 1 x heavy suffolk latch, 1 x 6" x 1/2" brenton padbolt and fixings to suit.



GATEMATE® HINGES

GATEMATE®
Superior Gate Furniture

HINGE LOADING APPLICATION PER PAIR

When selecting hinges for your gate please ensure that you choose ones with the correct loading application.

This is only approximate hinge loading application as none of our hinges are tested.

For heavier gates, an additional hinge can be added.

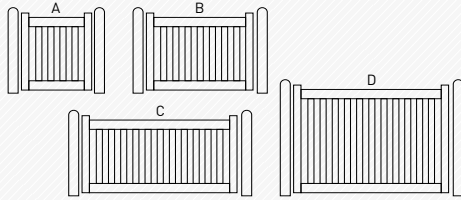

GATE TYPE	CLASS	WEIGHT	MAXIMUM WIDTH
A	SMALL GATES AND DOORS	UP TO 10KG	900MM
B	MEDIUM GATE	UP TO 20KG	1200MM
C	LARGE GATE	UP TO 50KG	1800MM
D	EXTRA LARGE GATE	UP TO 80KG	2400MM

GATEMATE® Tee & Strap Hinges

GATEMATE®
Superior Gate Furniture

TEE HINGES

- Suitable for a huge range of gates; with light, medium and heavy weights
- Available in stainless steel and premium black (epoxy black on galvanised steel) finishes
- Ornamental designs also available
- Loading application A-D; see above
- Supplied with high performance ruspert woodscrews

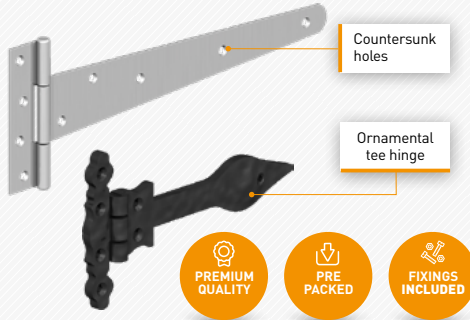

GATEMATE® Light Tee Hinges

FINISH	SIZE INS (MM)	UNIT Qty	LOAD APPL.	MIN. ORDER Qty	OUTER CARTON Qty	CODE
BZP	4 (100)	1 Pair	A	5 Pairs	40 Pairs	501 1002
BZP	6 (150)	1 Pair	A	5 Pairs	40 Pairs	501 1502
BZP	8 (200)	1 Pair	A	5 Pairs	40 Pairs	501 2002
BZP	10 (250)	1 Pair	A	5 Pairs	40 Pairs	501 2502
BZP	12 (300)	1 Pair	A	5 Pairs	20 Pairs	501 3002
Epoxy Black	4 (100)	1 Pair	A	5 Pairs	40 Pairs	501 1003
Epoxy Black	6 (150)	1 Pair	A	5 Pairs	40 Pairs	501 1503
Epoxy Black	8 (200)	1 Pair	A	5 Pairs	40 Pairs	501 2003
Epoxy Black	10 (250)	1 Pair	A	5 Pairs	40 Pairs	501 2503
Epoxy Black	12 (300)	1 Pair	A	5 Pairs	20 Pairs	501 3003

Material thickness between 1.00 and 1.50mm



LOOKING FOR ORNAMENTAL HINGES? TURN TO PAGE 54

GATEMATE® Medium Tee Hinges

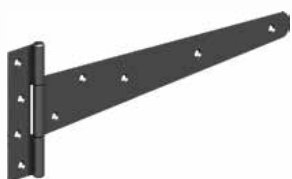

FINISH	SIZE INS (MM)	UNIT Qty	LOAD APPL.	MIN. ORDER Qty	OUTER CARTON Qty	CODE
Galvanised	12 (300)	1 Pair	B	5 Pairs	30 Pairs	502 3001
Galvanised	14 (350)	1 Pair	B	5 Pairs	30 Pairs	502 3501
Galvanised	15 (375)	1 Pair	B	5 Pairs	30 Pairs	502 3751
Galvanised	16 (400)	1 Pair	B	5 Pairs	30 Pairs	502 4001
Galvanised	18 (450)	1 Pair	B	5 Pairs	20 Pairs	502 4501
Galvanised	24 (600)	1 Pair	B	5 Pairs	-	502 6001
BZP	10 (250)	1 Pair	B	5 Pairs	30 Pairs	502 2502
BZP	12 (300)	1 Pair	B	5 Pairs	30 Pairs	502 3002
BZP	14 (350)	1 Pair	B	5 Pairs	30 Pairs	502 3502
BZP	15 (375)	1 Pair	B	5 Pairs	30 Pairs	502 3752
BZP	16 (400)	1 Pair	B	5 Pairs	30 Pairs	502 4002
BZP	18 (450)	1 Pair	B	5 Pairs	20 Pairs	502 4502
BZP	24 (600)	1 Pair	B	5 Pairs	-	502 6002
Epoxy Black	10 (250)	1 Pair	B	5 Pairs	30 Pairs	502 2503
Epoxy Black	12 (300)	1 Pair	B	5 Pairs	30 Pairs	502 3003
Epoxy Black	14 (350)	1 Pair	B	5 Pairs	30 Pairs	502 3503
Epoxy Black	15 (375)	1 Pair	B	5 Pairs	30 Pairs	502 3753
Epoxy Black	16 (400)	1 Pair	B	5 Pairs	30 Pairs	502 4003
Epoxy Black	18 (450)	1 Pair	B	5 Pairs	20 Pairs	502 4503
Epoxy Black	24 (600)	1 Pair	B	5 Pairs	-	502 6003

Material thickness between 1.80 and 2.50mm

GATEMATE® Medium Tee Hinges (1.5 Pairs)

An extra tee hinge per set gives additional strength for higher use and heavier application.



FINISH	SIZE INS (MM)	UNIT Qty	LOAD APPL.	MIN. ORDER Qty	CODE
Galvanised	18 (450)	1.5 Pairs	B	5 Packs	502 4511
Epoxy Black	18 (450)	1.5 Pairs	B	5 Packs	502 4513

GATEMATE® Heavy Tee Hinges



FINISH	SIZE INS (MM)	UNIT Qty	LOAD APPL.	MIN. ORDER Qty	CODE
BZP	4 (100)	1 Pair	C	5 Pairs	516 1002
BZP	12 (300)	1 Pair	C	5 Pairs	516 3002
BZP	15 (375)	1 Pair	C	5 Pairs	516 3752
BZP	18 (450)	1 Pair	C	5 Pairs	516 4502

Material thickness between 2.00 and 3.00mm

GATEMATE® Strong Tee Hinges

FINISH	SIZE INS (MM)	UNIT Qty	LOAD APPL.	MIN. ORDER Qty	CODE
Galvanised	6 (150)	1 Pair	C	5 Pairs	503 1501
Galvanised	8 (200)	1 Pair	C	5 Pairs	503 2001
Galvanised	10 (250)	1 Pair	C	5 Pairs	503 2501
Galvanised	12 (300)	1 Pair	C	5 Pairs	503 3001
Galvanised	14 (350)	1 Pair	C	5 Pairs	503 3501
Galvanised	16 (400)	1 Pair	C	5 Pairs	503 4001
Galvanised	18 (450)	1 Pair	C	5 Pairs	503 4501
Galvanised	20 (500)	1 Pair	C	5 Pairs	503 5001
Galvanised	24 (600)	1 Pair	C	5 Pairs	503 6001
BZP	6 (150)	1 Pair	C	5 Pairs	503 1502
BZP	8 (200)	1 Pair	C	5 Pairs	503 2002
BZP	10 (250)	1 Pair	C	5 Pairs	503 2502
Epoxy Black	12 (300)	1 Pair	C	5 Pairs	503 3003
Epoxy Black	14 (350)	1 Pair	C	5 Pairs	503 3503
Epoxy Black	16 (400)	1 Pair	C	5 Pairs	503 4003
Epoxy Black	18 (450)	1 Pair	C	5 Pairs	503 4503
Epoxy Black	24 (600)	1 Pair	C	5 Pairs	503 6003
Premium Black	18 (450)	1 Pair	C	5 Pairs	503 450B
Premium Black	24 (600)	1 Pair	C	5 Pairs	503 600B

Material thickness between 2.00 and 3.50mm



GATEMATE® Weighty Scotch Tee Hinges

FINISH	SIZE INS (MM)	UNIT Qty	LOAD APPL.	MIN. ORDER Qty	OUTER CARTON Qty	CODE
Galvanised	4 (100)	1 Pair	C	5 Pairs	30 Pairs	505 1001
Galvanised	6 (150)	1 Pair	C	5 Pairs	30 Pairs	505 1501
Galvanised	8 (200)	1 Pair	C	5 Pairs	30 Pairs	505 2001
Galvanised	10 (250)	1 Pair	C	5 Pairs	-	505 2501
Galvanised	12 (300)	1 Pair	C	5 Pairs	-	505 3001
Galvanised	14 (350)	1 Pair	C	5 Pairs	-	505 3501
Galvanised	16 (400)	1 Pair	C	5 Pairs	-	505 4001
Galvanised	18 (450)	1 Pair	D	5 Pairs	-	505 4501
Stainless Steel*	12 (300)	1 Pair	C	1 Pair	5 Pairs	505 3006

Material thickness between 2.00 and 4.00mm

*Constructed from Grade 316 Stainless Steel



GATEMATE®
Superior Gate Furniture

HEAVY DUTY OFFSET TEE HINGE

- The only offset tee hinge on the market!
- Provides increased strength over standard butt hinges
- Suitable for arched top and flat style continental gates where there are no cross braces
- High performance, ruspert coated woodscrews included for excellent corrosion resistance

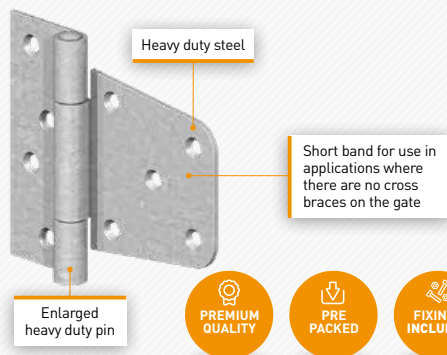

GATEMATE® Heavy Duty Offset Tee Hinges

FINISH	SIZE INS (MM)	UNIT Qty	LOAD APPL.	MIN. ORDER Qty	CODE
Galvanised	3½ (89)	1 Pair	C	5 Pairs	602 0011
Epoxy Black	3½ (89)	1 Pair	C	5 Pairs	602 0013

Material thickness 2.50mm



**THE ONLY
HEAVY DUTY
OFFSET TEE
HINGE ON THE
MARKET!**

GATEMATE® Medium Strap Hinges

FINISH	SIZE INS (MM)	UNIT Qty	LOAD APPL.	MIN. ORDER Qty	CODE
BZP	8 (200)	1 Pair	B	5 Pairs	522 2002
BZP	10 (250)	1 Pair	B	5 Pairs	522 2502
BZP	12 (300)	1 Pair	B	5 Pairs	522 3002



GATEMATE® Band & Hook Hinges

GATEMATE®
Superior Gate Furniture

STRAIGHT BAND & HOOK ON PLATE

Available in a range of sizes and finishes

- Suitable for wooden gates
- Loading Application B - D; see page 27

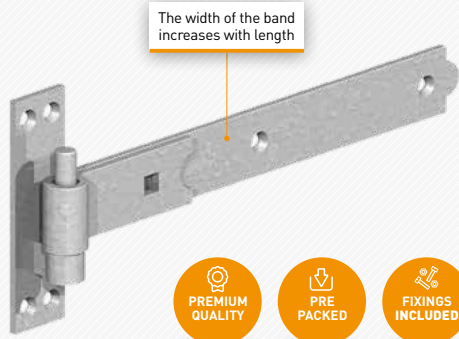

GATEMATE® Straight Band & Hook on Plate

FINISH	SIZE INS (MM)	UNIT Qty	LOAD APPL.	MIN. ORDER Qty	CODE
Galvanised	10 (250)	1 Pair	B	5 Pairs	506 2501
Galvanised	12 (300)	1 Pair	B	5 Pairs	506 3001
Galvanised	14 (350)	1 Pair	B	5 Pairs	506 3501
Galvanised	16 (400)	1 Pair	B	5 Pairs	506 4001
Galvanised	18 (450)	1 Pair	C	5 Pairs	506 4501
Galvanised	20 (500)	1 Pair	C	5 Pairs	506 5001
Galvanised	24 (600)	1 Pair	C	2 Pairs	506 6001
Galvanised	30 (750)	1 Pair	D	2 Pairs	506 7501
Galvanised	36 (900)	1 Pair	D	2 Pairs	506 9001
Epoxy Black	10 (250)	1 Pair	B	5 Pairs	506 2503
Epoxy Black	12 (300)	1 Pair	B	5 Pairs	506 3003
Epoxy Black	14 (350)	1 Pair	B	5 Pairs	506 3503
Epoxy Black	16 (400)	1 Pair	B	5 Pairs	506 4003
Epoxy Black	18 (450)	1 Pair	C	5 Pairs	506 4503
Epoxy Black	24 (600)	1 Pair	C	2 Pairs	506 6003
Epoxy Black	30 (750)	1 Pair	D	2 Pairs	506 7503
Epoxy Black	36 (900)	1 Pair	D	2 Pairs	506 9003
Stainless Steel*	18 (450)	1 Pair	C	1 Pair	506 4506

*Constructed from Grade 316 Stainless Steel

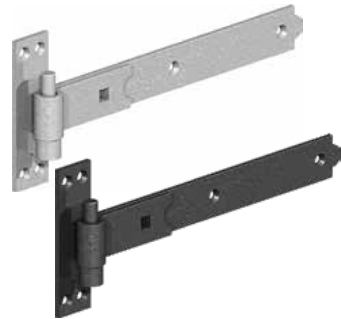

GATEMATE®
Superior Gate Furniture

CRANKED BAND & HOOK ON PLATE

Designed for installations where the gate is flush with the front of the post

- Available in a range of sizes and finishes including stainless steel and premium black (epoxy black on galvanised steel) finishes
- Suitable for wooden gates
- Loading application B - D; see page 27

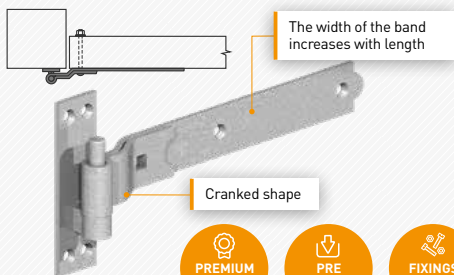

GATEMATE® Cranked Band & Hook on Plate

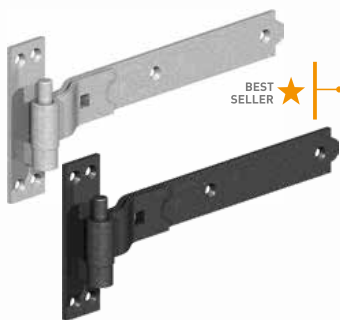

FINISH	SIZE INS (MM)	UNIT Qty	LOAD APPL.	MIN. ORDER Qty	CODE
Galvanised	10 (250)	1 Pair	B	5 Pairs	507 2501
Galvanised	12 (300)	1 Pair	B	5 Pairs	507 3001
Galvanised	14 (350)	1 Pair	B	5 Pairs	507 3501
Galvanised	16 (400)	1 Pair	B	5 Pairs	507 4001
Galvanised	18 (450)	1 Pair	C	5 Pairs	507 4501
Galvanised	20 (500)	1 Pair	C	5 Pairs	507 5001
Galvanised	24 (600)	1 Pair	C	2 Pairs	507 6001
Galvanised	30 (750)	1 Pair	D	2 Pairs	507 7501
Galvanised	36 (900)	1 Pair	D	2 Pairs	507 9001
Epoxy Black	12 (300)	1 Pair	B	5 Pairs	507 3003
Epoxy Black	14 (350)	1 Pair	B	5 Pairs	507 3503
Epoxy Black	16 (400)	1 Pair	B	5 Pairs	507 4003
Epoxy Black	18 (450)	1 Pair	C	5 Pairs	507 4503
Epoxy Black	24 (600)	1 Pair	C	2 Pairs	507 6003
Epoxy Black	30 (750)	1 Pair	D	2 Pairs	507 7503
Epoxy Black	36 (900)	1 Pair	D	2 Pairs	507 9003
Premium Black	18 (450)	1 Pair	C	5 Pairs	507 450B
Premium Black	24 (600)	1 Pair	C	2 Pairs	507 600B
Premium Black	30 (750)	1 Pair	D	2 Pairs	507 750B
Premium Black	36 (900)	1 Pair	D	2 Pairs	507 900B
Stainless Steel*	18 (450)	1 Pair	C	1 Pair	507 4506
Stainless Steel*	24 (600)	1 Pair	C	1 Pair	507 6006

*Constructed from Grade 316 Stainless Steel

GATEMATE® Cranked Curve Rail Hinges Kit

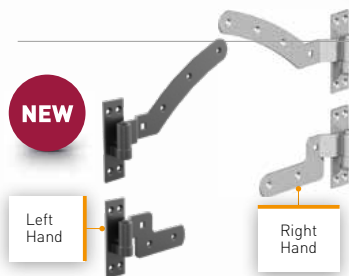

FINISH	LENGTH INS (MM)	DESC	LOAD APPL.	MIN. ORDER Qty	CODE
Galvanised	12 (300)	Left Handed	C	5	598 0001
Galvanised	12 (300)	Right Handed	C	5	598 0011
Premium Black	12 (300)	Left Handed	C	5	598 000B
Premium Black	12 (300)	Right Handed	C	5	598 001B

ADJUSTABLE BAND & HOOKS ON PLATES

These heavy duty, robust hinges provide full adjustability; allowing the installer to align gates both during fitting and afterwards to compensate for gate drop over time. Ideal for use on high-use/heavy gates and external doors.

- Easy to fit and adjust
- Available in a range of sizes and finishes including stainless steel and premium black (epoxy black on galvanised steel) finishes
- Wide range of sizes
- Loading application B - D; see page 27

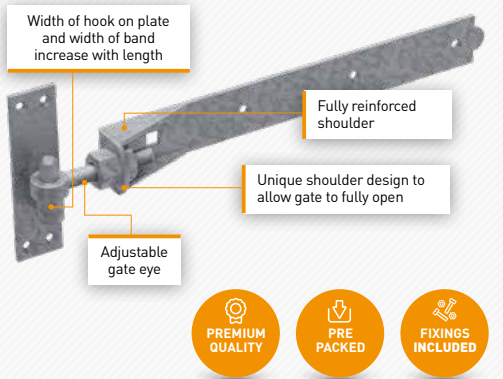

GATEMATE® Adjustable Band & Hook on Plate

These GATEMATE® band and hook hinges are both easy to fit and use; allowing the installer to align gates during fitting, and adjust afterwards to compensate for gate drop over time

FINISH	SIZE INS (MM)	UNIT Qty	LOAD APPL.	MIN. ORDER Qty	CODE
Galvanised	14 (350)	1 Pair	B	5 Pairs	508 3501
Galvanised	18 (450)	1 Pair	C	5 Pairs	508 4501
Galvanised	24 (600)	1 Pair	C	2 Pairs	508 6001
Galvanised	30 (750)	1 Pair	D	2 Pairs	508 7501
Galvanised	36 (900)	1 Pair	D	1 Pair	508 9001
Epoxy Black	18 (450)	1 Pair	C	5 Pairs	508 4503
Epoxy Black	24 (600)	1 Pair	C	2 Pairs	508 6003
Epoxy Black	30 (750)	1 Pair	D	2 Pairs	508 7503
Epoxy Black	36 (900)	1 Pair	D	1 Pair	508 9003
Premium Black	18 (450)	1 Pair	C	5 Pairs	508 450B
Premium Black	24 (600)	1 Pair	C	2 Pairs	508 600B
Premium Black	30 (750)	1 Pair	D	2 Pairs	508 750B
Premium Black	36 (900)	1 Pair	D	1 Pair	508 900B
Stainless Steel*	18 (450)	1 Pair	C	1 Pair	508 4506
Stainless Steel*	24 (600)	1 Pair	C	1 Pair	508 6006
Stainless Steel*	36 (900)	1 Pair	D	1 Pair	508 9006



★ BEST SELLER

1 pair includes: 2 x adjustable bands, 2 x adjustable gate eyes, 2 x hooks on plates and all required fixings
*Constructed from Grade 316 Stainless Steel

GATEMATE® Braced Adjustable Band & Hook on Plate

FINISH	SIZE INS (MM)	UNIT Qty	LOAD APPL.	MIN. ORDER Qty	CODE
Galvanised	14 (350)	1 Pair	B	5 Pairs	598 0101

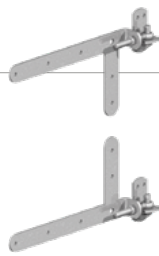

GATEMATE® Heavy Reversible Hinges



GATEMATE® Heavy Reversible Hinges

FINISH	SIZE INS (MM)	UNIT Qty	LOAD APPL.	MIN. ORDER Qty	CODE
Galvanised	12 (300)	1 Pair	B	5 Pairs	509 3001
Galvanised	14 (350)	1 Pair	B	5 Pairs	509 3501
Galvanised	16 (400)	1 Pair	B	5 Pairs	509 4001
Galvanised	18 (450)	1 Pair	C	5 Pairs	509 4501
Galvanised	20 (500)	1 Pair	C	5 Pairs	509 5001
Galvanised	24 (600)	1 Pair	C	2 Pairs	509 6001
Galvanised	30 (750)	1 Pair	D	2 Pairs	509 7501
Galvanised	36 (900)	1 Pair	D	2 Pairs	509 9001
Epoxy Black	12 (300)	1 Pair	B	5 Pairs	509 3003
Epoxy Black	14 (350)	1 Pair	B	5 Pairs	509 3503
Epoxy Black	16 (400)	1 Pair	B	5 Pairs	509 4003
Epoxy Black	18 (450)	1 Pair	C	5 Pairs	509 4503
Epoxy Black	20 (500)	1 Pair	C	5 Pairs	509 5003
Epoxy Black	24 (600)	1 Pair	C	2 Pairs	509 6003
Epoxy Black	30 (750)	1 Pair	D	2 Pairs	509 7503
Epoxy Black	36 (900)	1 Pair	D	2 Pairs	509 9003
Premium Black	18 (450)	1 Pair	C	5 Pairs	509 450B
Premium Black	24 (600)	1 Pair	C	2 Pairs	509 600B
Premium Black	36 (900)	1 Pair	D	1 Pair	509 900B

GATEMATE® Butt Hinges

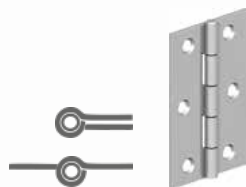

GATEMATE® Butt Hinges 1838

FINISH	SIZE INS (MM)	UNIT Qty	LOAD APPL.	MIN. ORDER Qty	CODE
BZP	2 (50)	1 Pair	A	5 Pairs	504 0502
BZP	3 (75)	1 Pair	A	5 Pairs	504 0752
BZP	4 (100)	1 Pair	A	5 Pairs	504 1002
BZP	6 (150)	1 Pair	A	5 Pairs	504 1502

GATEMATE® Strong Butt Hinges 451

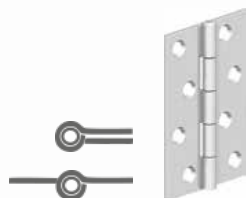

FINISH	SIZE INS (MM)	UNIT Qty	LOAD APPL.	MIN. ORDER Qty	CODE
BZP	4 (100)	1 Pair	A	5	545 1002

Grade 11 Stainless Steel Ball Bearing Butt Hinge

- For indoor use on timber doors
- High quality smooth ball bearing action
- Includes stainless steel screws

FINISH	SIZE INS (MM)	UNIT Qty	LOAD APPL.	MIN. ORDER Qty	CODE
Brushed Stainless Steel*	3 x 2 (75 x 50)	1 Pair	A	1 Pair	027 0756B

*Constructed from Grade 316 stainless steel



Grade 13 Stainless Steel Ball Bearing Butt Hinge

- Certified CE13 BSN1935
- Includes stainless steel screws
- Certifire approved product
- Quality and performance BSEN1935
- Fire safety BSEN1634 - for use on 30 minute and 1 hour fire doors

FINISH	SIZE INS (MM)	UNIT Qty	LOAD APPL.	MIN. ORDER Qty	INNER CARTON Qty	OUTER CARTON Qty	CODE
Brushed Stainless Steel*	4 x 3 (102 x 76)	1 Pair	A	1 Pair	1 Pair	40 Pairs	027 1006B
Brushed Stainless Steel*	4 x 3 (102 x 76)	1.5 Pairs	A	1 Pack	3 Packs	25 Packs	027 1016B
Polished Stainless Steel*	4 x 3 (102 x 76)	1.5 Pairs	A	1 Pack	3 Packs	25 Packs	027 1016P

*Constructed from Grade 316 stainless steel



GATEMATE® LATCHES, CATCHES, HOOKS & BOLTS

GATEMATE® Latches

GATEMATE®
Superior Gate Furniture

SUFFOLK LATCHES

- Available in light and heavy duty options and a range of finishes and styles
- Heavy pattern provides excellent strength for heavy use applications
- High performance, ruspert coated woodscrews included for excellent corrosion resistance
- Suitable for up to 3" gates

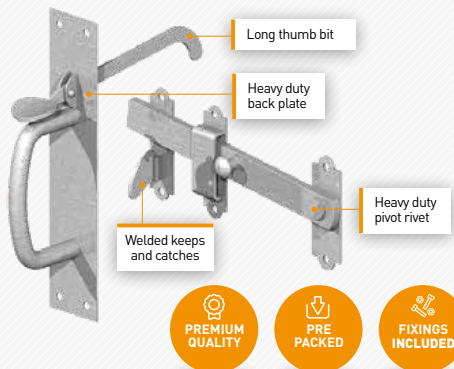

LOOKING FOR AN ORNAMENTAL SUFFOLK LATCH? TURN TO PAGE 5555



GATEMATE® Light Suffolk Latch Set

FINISH	THUMB LENGTH INS (MM)	MIN. ORDER Qty	OUTER CARTON Qty	CODE
BZP	4 ½" [115]	5	30	523 0012
Epoxy Black	4 ½" [115]	5	30	523 0013

GATEMATE® Heavy Suffolk Latch Set

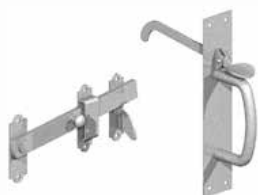

FINISH	THUMB LENGTH INS (MM)	MIN. ORDER Qty	OUTER CARTON Qty	CODE
Galvanised	4 ½" [115]	5	30	523 0021
BZP	4 ½" [115]	5	30	523 0022
Epoxy Black	4 ½" [115]	5	30	523 0023
Premium Black	4 ½" [115]	5	30	523 002B

GATEMATE® Heavy Gothic Suffolk Latch Set

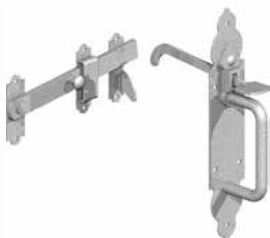

FINISH	THUMB LENGTH INS (MM)	MIN. ORDER Qty	OUTER CARTON Qty	CODE
Galvanised	4 ½" [115]	5	30	523 0031
BZP	4 ½" [115]	5	30	523 0032
Epoxy Black	4 ½" [115]	5	30	523 0033
Stainless Steel*	4 ½" [115]	1	30	523 0036

*Constructed from Grade 316 Stainless Steel

RING GATE LATCH

- Very popular within the range; featuring a choice of sizes and finishes
- Ornamental designs also available
- High performance, rusper coated woodscrews included for excellent corrosion resistance

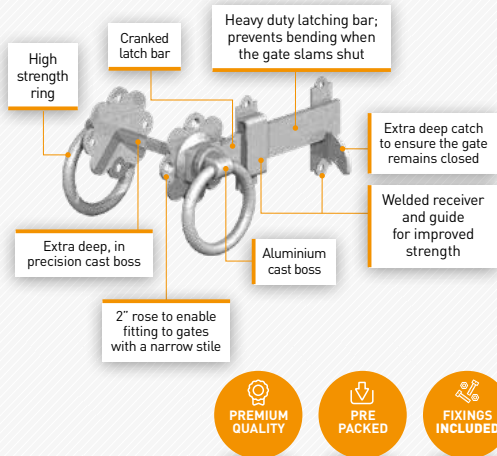

GATEMATE® Ring Gate Latch

FINISH	SIZE INS (MM)	MIN. ORDER Qty	OUTER CARTON Qty	CODE
Galvanised	4 (100)	5	30	525 1001
Galvanised	5 (125)	5	30	525 1251
Galvanised	6 (150)	5	30	525 1501
Galvanised	7 (175)	5	30	525 1751
BZP	5 (125)	5	30	525 1252
BZP	6 (150)	5	30	525 1502
Epoxy Black	5 (125)	5	30	525 1253
Epoxy Black	6 (150)	5	30	525 1503
Epoxy Black	7 (175)	5	30	525 1753
Premium Black	5 (125)	5	-	525 125B
Premium Black	6 (150)	5	-	525 150B
Stainless Steel*	6 (150)	1	-	525 1506

*Constructed from Grade 316 Stainless Steel

LOOKING FOR 8" OR 10" RING GATE LATCHES? TURN TO ORNAMENTAL ON PAGE 5555

★ BEST SELLER



GATEMATE® Plain Ring Handle Only

FINISH	SIZE INS (MM)	MIN. ORDER Qty	CODE
Galvanised	2½ (65)	5	526 0001
Epoxy Black	2½ (65)	5	526 0003



GATEMATE® Twisted Ring Gate Latch



FINISH	SIZE INS (MM)	MIN. ORDER Qty	OUTER CARTON Qty	CODE
Galvanised	6 (150)	5	30	524 1501
Epoxy Black	6 (150)	5	30	524 1503

GATEMATE® Catches

GATEMATE® Medium Auto Gate Catch



FINISH	MIN. ORDER Qty	OUTER CARTON Qty	CODE
Galvanised	5	30	521 0011
BZP	5	30	521 0012
Epoxy Black	5	30	521 0013

GATEMATE® Large Auto Gate Catch

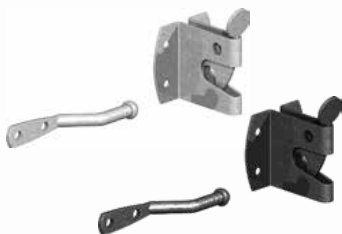

FINISH	MIN. ORDER Qty	OUTER CARTON Qty	CODE
Galvanised	5	30	521 0021
Epoxy Black	5	30	521 0023

GATEMATE® Easy-Close Auto Gate Catch

Brass pin for greater rust resistance



FINISH	SIZE INS (MM)	MIN. ORDER Qty	CODE
Galvanised	2 (50)	5	601 0011
BZP	2 (50)	5	601 0012
Epoxy Black	2 (50)	5	601 0013

GATEMATE® Kenham Gate Catch

FINISH	SIZE INS (MM)	MIN. ORDER Qty	CODE
BZP	3 (75)	5	566 0752



GATEMATE® Hooks

GATEMATE®
Superior Gate Furniture

CABIN HOOKS

- Range of patterns and finishes available including stainless steel and premium black (epoxy black on galvanised steel)
- Available up to 600mm (24") long

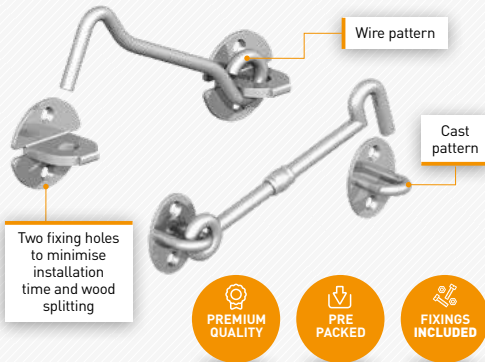

GATEMATE® Wire Pattern Cabin Hooks

FINISH	SIZE INS (MM)	MIN. ORDER Qty	CODE
Galvanised	4 (100)	5	532 1001
Galvanised	6 (150)	5	532 1501
Galvanised	8 (200)	5	532 2001
Galvanised	10 (250)	5	532 2501
Galvanised	12 (300)	5	532 3001
Galvanised	24 (600) *	5	532 6001
Epoxy Black	4 (100)	5	532 1003
Epoxy Black	6 (150)	5	532 1503
Epoxy Black	8 (200)	5	532 2003
Epoxy Black	12 (300)	5	532 3003
Epoxy Black	24 (600) *	5	532 6003

*Heavy duty





GATEMATE® Cast Pattern Cabin Hooks

FINISH	SIZE INS (MM)	MIN. ORDER Qty	CODE
Galvanised	4 (100)	5	541 1001
Galvanised	6 (150)	5	541 1501
Galvanised	8 (200)	5	541 2001
Galvanised	10 (250)	5	541 2501
Epoxy Black	4 (100)	5	541 1003
Epoxy Black	6 (150)	5	541 1503
Epoxy Black	8 (200)	5	541 2003
Epoxy Black	10 (250)	5	541 2503
Premium Black	8 (200)	5	541 200B
Stainless Steel*	4 (100)	5	541 1006

*Constructed from Grade 316 Stainless Steel

GATEMATE® Kick Over Stable Latch



FINISH	SIZE INS (MM)	MIN. ORDER Qty	CODE
Galvanised	9½ (240)	5	530 2401

GATEMATE® Narrow Pattern Kick Over Latch



FINISH	SIZE INS (MM)	MIN. ORDER Qty	CODE
Galvanised	9½ (240)	5	530 2451

GATEMATE® Turn Buttons Cast



FINISH	SIZE INS (MM)	UNIT Qty	MIN. ORDER Qty	CODE
BZP	2 (50)	Pack of 2	5	527 0502
Epoxy Black	2 (50)	Pack of 2	5	527 0503

GATEMATE® Gate Return Spring



FINISH	SIZE INS (MM)	MIN. ORDER Qty	OUTER CARTON Qty	CODE
BZP	8 (200)	5	40	526 2002
BZP	10 (250)	5	40	526 2502
Epoxy Black	8 (200)	5	40	526 2003
Epoxy Black	10 (250)	5	40	526 2503

GATEMATE® Door-Gate Stop

FINISH	SIZE INS (MM)	MIN. ORDER Qty	CODE
Epoxy Grey	6 (150)	5	531 1503



GATEMATE® Bolts

GATEMATE® Tower Bolt

FINISH	SIZE INS (MM)	MIN. ORDER Qty	CODE
Galvanised	3 (75)	5	510 0751
Galvanised	4 (100)	5	510 1001
Galvanised	6 (150)	5	510 1501
Galvanised	8 (200)	5	510 2001
Galvanised	10 (250)	5	510 2501
BZP	4 (100)	5	510 1002
BZP	6 (150)	5	510 1502
BZP	8 (200)	5	510 2002
Epoxy Black	3 (75)	5	510 0753
Epoxy Black	4 (100)	5	510 1003
Epoxy Black	6 (150)	5	510 1503
Epoxy Black	8 (200)	5	510 2003
Epoxy Black	10 (250)	5	510 2503

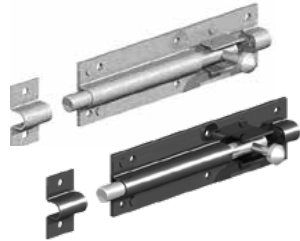

GATEMATE® Necked Tower Bolt

FINISH	SIZE INS (MM)	MIN. ORDER Qty	CODE
Galvanised	6 (150)	5	511 1501
Epoxy Black	6 (150)	5	511 1503



GATEMATE® Oval Padbolt

FINISH	SIZE INS (MM)	MIN. ORDER Qty	OUTER CARTON Qty	CODE
Galvanised	4 (100)	5	30	514 1001
BZP	4 (100)	5	30	514 1002
Epoxy Black	4 (100)	5	30	514 1003



GATEMATE®
Superior Gate Furniture

BRENTON PADBOLTS

These brenton padbolts are ideal for use on gates and sheds alike.

- ½" or ¾" diameter shoots
- Available in a range of finishes, including stainless steel and premium black (epoxy black on galvanised steel)
- All fittings are welded through to the back plate instead of being punched to provide more security

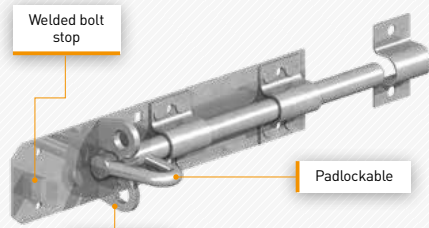

Welded
knuckle

Padlockable



GATEMATE® Brenton Padbolt with ½" Shoot



FINISH	SIZE INS (MM)	MIN. ORDER Qty	OUTER CARTON Qty	CODE
Galvanised	4 (100)	5	30	512 1001
Galvanised	6 (150)	5	30	512 1501
Galvanised	8 (200)	5	30	512 2001
Galvanised	10 (250)	5	30	512 2501
BZP	4 (100)	5	30	512 1002
BZP	6 (150)	5	30	512 1502
BZP	8 (200)	5	30	512 2002
Epoxy Black	4 (100)	5	30	512 1003
Epoxy Black	6 (150)	5	30	512 1503
Epoxy Black	8 (200)	5	30	512 2003
Premium Black	6 (150)	5	30	512 150B
Premium Black	8 (200)	5	30	512 200B
Stainless Steel*	6 (150)	1	5	512 1506

*Constructed from Grade 316 Stainless Steel

GATEMATE® Brenton Padbolt with ¾" Shoot



FINISH	SIZE INS (MM)	MIN. ORDER Qty	OUTER CARTON Qty	CODE
Galvanised	6 (150)	5	30	513 1501
Galvanised	8 (200)	5	30	513 2001
Galvanised	10 (250)	5	30	513 2501
Galvanised	12 (300)	5	30	513 3001
Stainless Steel*	8 (200)	1	5	513 2006

*Constructed from Grade 316 Stainless Steel

GATEMATE® Brenton Padbolt with ¾" Shoot & Elongated Keep



FINISH	SIZE INS (MM)	MIN. ORDER Qty	CODE
Galvanised	6 (150)	5	513 1511
Galvanised	8 (200)	5	513 2011

GATEMATE® Brenton Padbolt Kit with 2" Padlock

FINISH	SIZE INS (MM)	SHOOT GAUGE INS (MM)	MIN. ORDER Qty	CODE
Galvanised	6 (150)	½ (12)	5	512 1511
BZP	6 (150)	½ (12)	5	512 1512



GATEMATE® Heavy Cross Pattern Door Bolt

FINISH	SIZE INS (MM)	MIN. ORDER Qty	CODE
Galvanised	12 (300)	5	527 3001
Galvanised	15 (375)	5	527 3751
Galvanised	18 (450)	5	527 4501
Galvanised	24 (600)	5	527 6001



GATEMATE® Autolock Animal Bolt

FINISH	SIZE INS (MM)	MIN. ORDER Qty	CODE
Galvanised	9 (230)	5	515 2301

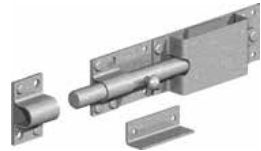

GATEMATE® Spring-Loaded Animal Bolt

FINISH	SIZE INS (MM)	SHOOT GAUGE INS (MM)	MIN. ORDER Qty	OUTER CARTON Qty	CODE
BZP	4½ (115)	½ (12)	5	30	516 0122



GATEMATE® Spring-Loaded Bolt

FINISH	SIZE INS (MM)	SHOOT GAUGE INS (MM)	MIN. ORDER Qty	OUTER CARTON Qty	CODE
BZP	4½ (115)	½ (12)	5	30	516 1122
BZP	4 (105)	⅝ (16)	5	30	516 1162
BZP	2¾ (70)	⅜ (9½)	5	30	516 1952



GATEMATE® Spring-Loaded Bolt - Short Body

Features glow in the dark handle.

FINISH	SIZE INS (MM)*	MIN. ORDER Qty	CODE
BZP	½ x 3 (12 x 75)	5	516 3122
BZP	⅝ x 2½ (9.5 x 60)	5	516 3952

*Diameter x length



GLOW IN THE DARK HANDLE

GATEMATE®
Superior Gate Furniture

GARAGE DOOR BOLT

Also known as 'drop bolts', our Garage Door Bolts are popular in the range and are suitable for a variety of applications.

- Available in galvanised, epoxy black, premium black and stainless steel
- Comes with Square Plate and Tubular Receiver Sockets for your choice of installation

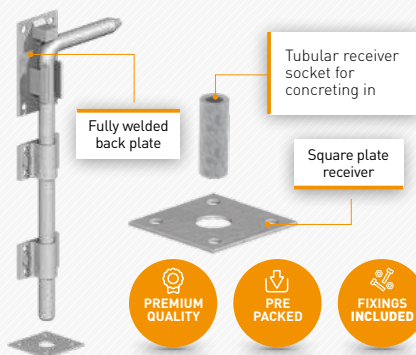

GATEMATE® Garage Door Bolt with 5/8" Shoot

Tubular and square plate receiver sockets included.



FINISH	SIZE INS (MM)	MIN. ORDER Qty	OUTER CARTON Qty	CODE
Galvanised	12 (300)	5	20	520 3001
Galvanised	18 (450)	5	20	520 4501
Galvanised	24 (600)	5	10	520 6001
Epoxy Black	12 (300)	5	20	520 3003
Epoxy Black	18 (450)	5	20	520 4503
Epoxy Black	24 (600)	5	10	520 6003
Premium Black	18 (450)	5	20	520 450B

GATEMATE® Heavy Locking Garage Door Bolt with 5/8" Shoot

FINISH	SIZE INS (MM)	MIN. ORDER Qty	OUTER CARTON Qty	CODE
Galvanised	18 (450)	1	5	517 4501
Stainless Steel*	18 (450)	1	-	517 4506

*Constructed from Grade 316 Stainless Steel

ORNAMENTAL
GARAGE DOOR
BOLTS
AVAILABLE
ON PAGE 56



GATEMATE® Cane Bolt

FINISH	SIZE INS (MM)	MIN. ORDER Qty	OUTER CARTON Qty	CODE
BZP	12 (300)	5	30	602 0042
BZP	18 (450)	5	30	602 0032



GATEMATE® Monkey Tail Bolt with 5/8" Square Shoot

FINISH	SIZE INS (MM)	MIN. ORDER Qty	CODE
Galvanised	12 (300)	5	519 3001
Galvanised	18 (450)	5	519 4501
Epoxy Black	12 (300)	5	519 3003
Epoxy Black	18 (450)	5	519 4503



GATEMATE® Chain Bolt

FINISH	SIZE INS (MM)	CHAIN LENGTH (MM)	MIN. ORDER Qty	CODE
BZP	8 (200)	550	5	517 2002



GATEMATE® Foot Bolt

FINISH	SIZE INS (MM)	MIN. ORDER Qty	CODE
Epoxy Black	8 (200)	5	518 2003



GATEMATE® Bow Handle Bolts with 5/8" Square Shoot

- Heavy duty bolt for use with high doors and gates
- Ideal for large doors such as barns and large out buildings
- Designed to be fitted in the vertical position, the bow handle bolt is versatile and can be fitted to shoot down into a floor mounted plate, or up into the door frame
- Galvanised for greater rust protection

FINISH	SIZE INS (MM)	MIN. ORDER Qty	CODE
Galvanised	12 (300)	5	576 3001
Galvanised	18 (450)	5	576 4501
Galvanised	24 (600)	5	576 6001



GATEMATE® LOCKING BARS AND HASP & STAPLES



GATEMATE® Locking Bars to Swivel

FINISH	SIZE INS (MM)	MIN. ORDER Qty	CODE
Galvanised	8 (200)	5	536 2001



GATEMATE® Safety Pattern Hasp & Staple

FINISH	SIZE INS (MM)	MIN. ORDER Qty	CODE
BZP	3 (75)	5	533 0752
BZP	4 (100)	5	533 1002
BZP	6 (150)	5	533 1502
Epoxy Black	4 (100)	5	533 1003
Epoxy Black	6 (150)	5	533 1503



GATEMATE® Heavy Safety Pattern Hasp & Staple

FINISH	SIZE INS (MM)	MIN. ORDER Qty	CODE
Galvanised	7 (180)	5	538 1801
Epoxy Black	7 (180)	5	538 1803



GATEMATE® Heavy Vertical Pattern Hasp & Staple

Features brass pins for added corrosion resistance.

FINISH	SIZE INS (MM)	MIN. ORDER Qty	CODE
Galvanised	6 (150)	5	534 1501
Epoxy Black	6 (150)	5	534 1503

GATEMATE® Heavy Hasp & Staple

Features brass pins for added corrosion resistance.

FINISH	SIZE INS (MM)	MIN. ORDER Qty	CODE
Galvanised	8 (200)	5	535 2001
Galvanised	10 (250)	5	535 2501
Epoxy Black	8 (200)	5	535 2003
Epoxy Black	10 (250)	5	535 2503



GATEMATE® Wire Pattern Hasp & Staple

FINISH	SIZE INS (MM)	MIN. ORDER Qty	CODE
BZP	4 (100)	5	536 1002
BZP	6 (150)	5	536 1502
Epoxy Black	4 (100)	5	536 1003
Epoxy Black	6 (150)	5	536 1503



GATEMATE® SIGNS & REFLECTORS

GATEMATE® 'Please Shut The Gate' Sign

FINISH	SIZE (MM)	MIN. ORDER Qty	CODE
Brass	160 x 55	5	544 0005
Chrome	160 x 55	5	544 000C



GATEMATE® 'Beware Of The Dog' Sign

FINISH	SIZE (MM)	MIN. ORDER Qty	CODE
Brass	160 x 55	5	544 0015
Chrome	160 x 55	5	544 001C



GATEMATE® High Visibility Reflectors

FINISH	SIZE (MM)	UNIT Qty	MIN. ORDER Qty	CODE
Red	110 x 45	Pack of 2	5	859 110R
White	110 x 45	Pack of 2	5	859 110W



GATEMATE® PREMIUM FINISH RANGE

Stainless Steel

Stainless steel is an iron alloy with high levels of chromium; giving it an external layer that is virtually rust free. Our premium range products are made from marine grade 316 stainless steel – ideal for coastal and other high-moisture environments.

See page 27 for table of loading applications for hinges.



GATEMATE® Weighty Scotch Tee Hinges



FINISH	SIZE INS (MM)	UNIT Qty	LOAD APPL.	MIN. ORDER Qty	OUTER CARTON Qty	CODE
Stainless Steel	12 (300)	1 Pair	C	1 Pair	5 Pairs	505 3006
Material thickness 3.00mm						

GATEMATE® Straight Band & Hook on Plate



FINISH	SIZE INS (MM)	UNIT Qty	LOAD APPL.	MIN. ORDER Qty	OUTER CARTON Qty	CODE
Stainless Steel	18 (450)	1 Pair	C	1 Pair	5 Pairs	506 4506

GATEMATE® Cranked Band & Hook on Plate



FINISH	SIZE INS (MM)	UNIT Qty	LOAD APPL.	MIN. ORDER Qty	CODE
Stainless Steel	18 (450)	1 Pair	C	1 Pair	507 4506
Stainless Steel	24 (600)	1 Pair	C	1 Pair	507 6006

GATEMATE® Adjustable Band & Hook on Plate



FINISH	SIZE INS (MM)	UNIT Qty	LOAD APPL.	MIN. ORDER Qty	CODE
Stainless Steel	18 (450)	1 Pair	C	1 Pair	508 4506
Stainless Steel	24 (600)	1 Pair	C	1 Pair	508 6006
Stainless Steel	36 (900)	1 Pair	D	1 Pair	508 9006

Grade 11 Stainless Steel Ball Bearing Butt Hinge

- For indoor use on timber doors
- High quality smooth ball bearing action
- Includes stainless steel screws

FINISH	SIZE INS (MM)	UNIT Qty	LOAD APPL.	MIN. ORDER Qty	CODE
Brushed Stainless Steel*	3 x 2 (75 x 50)	1 Pair	A	1 Pair	027 0756B

*Constructed from Grade 316 stainless steel



Grade 13 Stainless Steel Ball Bearing Butt Hinge

- Certified CE13 BSN1935
- Includes stainless steel screws
- Certifire approved product
- Quality and performance BSEN1935
- Fire safety BSEN1634 - for use on 30 minute and 1 hour fire doors

FINISH	SIZE INS (MM)	UNIT Qty	LOAD APPL.	MIN. ORDER Qty	INNER CARTON Qty	OUTER CARTON Qty	CODE
Brushed Stainless Steel*	4 x 3 (102 x 76)	1 Pair	A	1 Pair	1 Pair	40 Pairs	027 1006B
Brushed Stainless Steel*	4 x 3 (102 x 76)	1.5 Pairs	A	1 Pack	3 Packs	25 Packs	027 1016B
Polished Stainless Steel*	4 x 3 (102 x 76)	1.5 Pairs	A	1 Pack	3 Packs	25 Packs	027 1016P

*Constructed from Grade 316 stainless steel



GATEMATE® Heavy Gothic Suffolk Latch

FINISH	THUMB LENGTH INS (MM)	MIN. ORDER Qty	CODE
Stainless Steel	4½ (115)	1	523 0036



GATEMATE® Ring Gate Latch

FINISH	SIZE INS (MM)	MIN. ORDER Qty	CODE
Stainless Steel	6 (150)	1	525 1506



GATEMATE® Cast Pattern Cabin Hooks



FINISH	SIZE INS (MM)	MIN. ORDER Qty	CODE
Stainless Steel	4 (100)	5	541 1006

GATEMATE® Brenton Padbolt



FINISH	SIZE INS (MM)	SHOOT GAUGE INS (MM)	MIN. ORDER Qty	CODE
Stainless Steel	6 (150)	½ (12)	1	512 1506
Stainless Steel	8 (200)	⅝ (16)	1	513 2006

GATEMATE® Heavy Locking Garage Door Bolt with ⅝" Shoot



FINISH	SIZE INS (MM)	MIN. ORDER Qty	CODE
Stainless Steel	18 (450)	1	517 4506

Premium Black

A 'hot-dip' galvanised finish with a black polyester powder coating on top. This double layer results in a high level of corrosion resistance.

See page 27 for table of loading applications for hinges.

GATEMATE® Strong Tee Hinges

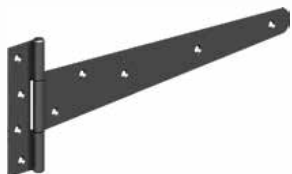

FINISH	SIZE INS (MM)	UNIT Qty	LOAD APPL.	MIN. ORDER Qty	CODE
Premium Black	18 (450)	1 Pair	C	5 Pairs	503 450B
Premium Black	24 (600)	1 Pair	C	5 Pairs	503 600B

GATEMATE® Cranked Band & Hook on Plate

FINISH	SIZE INS (MM)	UNIT Qty	LOAD APPL.	MIN. ORDER Qty	CODE
Premium Black	18 (450)	1 Pair	C	5 Pairs	507 450B
Premium Black	24 (600)	1 Pair	C	2 Pairs	507 600B
Premium Black	30 (750)	1 Pair	D	2 Pairs	507 750B
Premium Black	36 (900)	1 Pair	D	2 Pairs	507 900B



GATEMATE® Adjustable Band & Hook on Plate

FINISH	SIZE INS (MM)	UNIT Qty	LOAD APPL.	MIN. ORDER Qty	CODE
Premium Black	18 (450)	1 Pair	C	5 Pairs	508 450B
Premium Black	24 (600)	1 Pair	C	2 Pairs	508 600B
Premium Black	30 (750)	1 Pair	D	2 Pairs	508 750B
Premium Black	36 (900)	1 Pair	D	1 Pair	508 900B



GATEMATE® Heavy Reversible Hinges

FINISH	SIZE INS (MM)	UNIT Qty	LOAD APPL.	MIN. ORDER Qty	CODE
Premium Black	18 (450)	1 Pair	C	5 Pairs	509 450B
Premium Black	24 (600)	1 Pair	C	2 Pairs	509 600B
Premium Black	36 (900)	1 Pair	D	1 Pair	509 900B



GATEMATE® Cranked Curve Rail Hinges Kit

FINISH	SIZE INS (MM)	DESC	LOAD APPL.	MIN. ORDER Qty	CODE
Premium Black	12 (300)	Left Handed	C	5	598 000B
Premium Black	12 (300)	Right Handed	C	5	598 001B



NEW

Left Hand Illustrated

GATEMATE® Field Gate Double Strap Hinge Set



FINISH	SIZE INS (MM)	SUITABLE FOR	LOAD APPL.	MIN. ORDER Qty	OUTER CARTON Qty	CODE
Premium Black	24 (600)	3" gates	D	1	4	030 600B

GATEMATE® Field Gate Adjustable Double Strap Hinge Set

Full adjustability allows installer to easily fit and adjust gates to compensate for gate drop over time.



FINISH	SIZE INS (MM)	SUITABLE FOR	LOAD APPL.	MIN. ORDER Qty	OUTER CARTON Qty	CODE
Premium Black	24 (600)	3" gates	D	1	4	032 600B

GATEMATE® Double Field Gate Fastener Set with 18" Garage Door Bolt

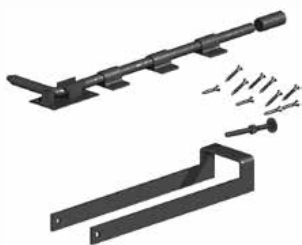

FINISH	SUITABLE FOR	MIN. ORDER Qty	OUTER CARTON Qty	CODE
Premium Black	3" gates	1	10	038 000B

GATEMATE® Field Gate Spring Fastener Set with Staple Catch



FINISH	SIZE INS (MM)	SUITABLE FOR	MIN. ORDER Qty	OUTER CARTON Qty	CODE
Premium Black	24 (600)	3" gates	1	10	036 000B

GATEMATE® Heavy Suffolk Latch Set

FINISH	MIN. ORDER Qty	CODE
Premium Black	5	523 002B



GATEMATE® Ring Gate Latch

FINISH	SIZE INS (MM)	MIN. ORDER Qty	CODE
Premium Black	5 (125)	5	525 125B
Premium Black	6 (150)	5	525 150B



GATEMATE® Cast Pattern Cabin Hooks

FINISH	SIZE INS (MM)	MIN. ORDER Qty	CODE
Premium Black	8 (200)	5	541 200B



GATEMATE® Brenton Padbolt

FINISH	SIZE INS (MM)	MIN. ORDER Qty	CODE
Premium Black	6 x ½ (150 x 12)	5	512 150B
Premium Black	8 x ½ (200 x 12)	5	512 200B



GATEMATE® Garage Door Bolt w/ 5/8" Shoot

FINISH	SIZE INS (MM)	MIN. ORDER Qty	OUTER CARTON Qty	CODE
Premium Black	18 (450)	5	20	520 450B



GATEMATE® ORNAMENTAL RANGE

GATEMATE® Ornamental Straight Band & Hook on Plate



FINISH	SIZE IN (MM)	UNIT Qty	LOAD APPL.	MIN. ORDER Qty	CODE
Dull Black	18 (450)	1 Pair	C	1 Pair	563 4503
Dull Black	24 (600)	1 Pair	C	1 Pair	563 6003

GATEMATE® Ornamental Tee Hinges



FINISH	SIZE IN (MM)	UNIT Qty	LOAD APPL.	MIN. ORDER Qty	CODE
Dull Black	6 (150)	1 Pair	A	5 Pairs	550 1503
Dull Black	9 (225)	1 Pair	A	5 Pairs	550 2253
Dull Black	12 (300)	1 Pair	A	5 Pairs	550 3003

GATEMATE® Ornamental Heavy Duty Tee Hinges



FINISH	SIZE IN (MM)	UNIT Qty	LOAD APPL.	MIN. ORDER Qty	CODE
Dull Black	12 (300)	1 Pair	B	5 Pairs	574 3003
Dull Black	14 (350)	1 Pair	B	5 Pairs	574 3503
Dull Black	16 (400)	1 Pair	B	5 Pairs	574 4003
Dull Black	18 (450)	1 Pair	B	5 Pairs	574 4503

GATEMATE® Ornamental Fleur De Leys Tee Hinges



FINISH	SIZE IN (MM)	UNIT Qty	LOAD APPL.	MIN. ORDER Qty	CODE
Dull Black	12 (300)	1 Pair	B	5 Pairs	551 3003

GATEMATE® Ornamental Butterfly Hinges



FINISH	SIZE IN (MM)	UNIT Qty	LOAD APPL.	MIN. ORDER Qty	CODE
Dull Black	2¼ x 2 (70 x 50)	1 Pair	A	5 Pairs	552 7053

GATEMATE® Ornamental Unequal Hinges

FINISH	SIZE INS (MM)	UNIT Qty	LOAD APPL.	MIN. ORDER Qty	CODE
Dull Black	4 x 3 (100 x 75)	1 Pair	A	5 Pairs	553 1003



GATEMATE® Ornamental Suffolk Latch

FINISH	SIZE INS (MM)	MIN. ORDER Qty	CODE
Dull Black	6 (150)	5	564 1503



GATEMATE® Ornamental Ring Gate Latch

FINISH	SIZE INS (MM)	MIN. ORDER Qty	CODE
Dull Black	8 (200)	5	561 2003
Dull Black	10 (250)	5	561 2503
Galvanised	8 (200)	5	561 2001
Galvanised	10 (250)	5	561 2501



GATEMATE® Ornamental Ring Handle Only

FINISH	SIZE INS (MM)	MIN. ORDER Qty	CODE
Galvanised	4 (100)	5	561 2001A
Dull Black	4 (100)	5	561 2003A





GATEMATE® Ornamental Cast Pattern Cabin Hooks

FINISH	SIZE INS (MM)	MIN. ORDER Qty	CODE
Dull Black	4 (100)	5	559 1003
Dull Black	6 (150)	5	559 1503



GATEMATE® Ornamental Heavy Duty Drop Bolts

FINISH	SIZE INS (MM)*	MIN. ORDER Qty	OUTER CARTON Qty	CODE
Galvanised	24 x 5/8 (600 x 16)	1	5	518 6001
Epoxy Black	24 x 5/8 (600 x 16)	1	5	518 6003

*Shoot length x diameter



GATEMATE® Ornamental Straight Door Bolts

FINISH	SIZE INS (MM)	MIN. ORDER Qty	CODE
Dull Black	6 (150)	5	557 1503
Dull Black	8 (200)	5	557 2003



GATEMATE® Ornamental Fleur De Leys Pull Handle

FINISH	SIZE INS (MM)	MIN. ORDER Qty	CODE
Dull Black	4 (100)	5	560 1003
Dull Black	7 (175)	5	560 1753



GATEMATE® Ornamental Lever Lock Handles

FINISH	SIZE INS (MM)	SPINDLE LENGTH INS (MM)	UNIT Qty	MIN. ORDER Qty	CODE
Dull Black	6 x 2 (150 x 50)	3 (75)	1 Pair	5 Pairs	555 1503



GATEMATE® Ornamental Fleur De Leys Lever Lock Handles

FINISH	SIZE INS (MM)	SPINDLE LENGTH INS (MM)	UNIT Qty	MIN. ORDER Qty	CODE
Dull Black	7 x 2 (175 x 50)	3 (75)	1 Pair	5 Pairs	556 1753

GATEMATE® Ornamental Cast Octagonal Door Knob

FINISH	SIZE INS (MM)	SPINDLE LENGTH INS (MM)	MIN. ORDER Qty	OUTER CARTON Qty	CODE
Dull Black	2 (50)	3 (75)	1	5	575 0503



GATEMATE® Ornamental Numerals

DESC	FINISH	SIZE INS (MM)	MIN. ORDER Qty	CODE
No. 0	Dull Black	3 (75)	5	570 0030
No. 1	Dull Black	3 (75)	5	570 0031
No. 2	Dull Black	3 (75)	5	570 0032
No. 3	Dull Black	3 (75)	5	570 0033
No. 4	Dull Black	3 (75)	5	570 0034
No. 5	Dull Black	3 (75)	5	570 0035
No. 6	Dull Black	3 (75)	5	570 0036
No. 7	Dull Black	3 (75)	5	570 0037
No. 8	Dull Black	3 (75)	5	570 0038
No. 9	Dull Black	3 (75)	5	570 0039



GATEMATE® Ornamental Door Studs

FINISH	SIZE INS (MM)	UNIT Qty	MIN. ORDER Qty	CODE
Dull Black	¾ (19)	Pack of 10	5 Packs	562 0193



GATEMATE® Ornamental Letter Plate

FINISH	SIZE INS (MM)	MIN. ORDER Qty	CODE
Dull Black	10 x 3 (250 x 75)	5	565 2503



GATEMATE® Ornamental Fleur De Leys Letter Plate

FINISH	SIZE INS (MM)	MIN. ORDER Qty	CODE
Dull Black	13 x 3¼ (330 x 85)	5	566 2503



GATEMATE® Ornamental Casement Stay

FINISH	SIZE INS (MM)	MIN. ORDER Qty	CODE
Dull Black	10 (250)	5	558 2503



GATEMATE® HIGH PERFORMANCE RANGE

Hinges

GATEMATE® Standard Unsprung Gate Hinges

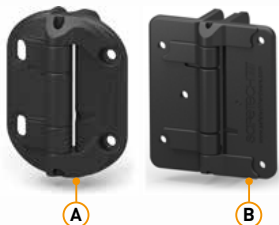

FINISH	SIZE (MM)	SUITABLE FOR	UNIT Qty	MIN. ORDER Qty	CODE
Black Composite/Polymer (A)	90 x 70	25-50mm posts	1 Pair	1 Pair	891 1F13
Black Composite/Polymer (B)	110 x 75	40 - 75mm posts	1 Pair	1 Pair	891 1F23

GATEMATE® Self-Closing Fixed Spring Hinges with Legs



FINISH	SIZE (MM)	SUITABLE FOR	UNIT Qty	MIN. ORDER Qty	CODE
Black Composite/Polymer	110 x 75	40-75mm posts	1 Pair	1 Pair	893 1F23

GATEMATE® Self-Closing Hinges with Legs

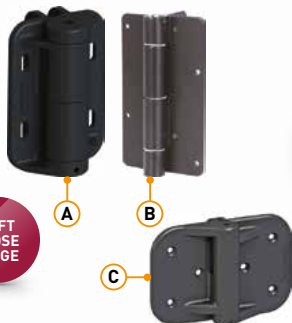

FINISH	SIZE (MM)	UNIT Qty	MIN. ORDER Qty	CODE
Black Composite/Polymer (A)	108 x 63.5	1 Pair	1 Pair	894 1F23
Black Composite/Polymer (C)	108 x 158	1 Pair	1 Pair	894 1F43
Aluminium/Black (B)	146 x 89	1 Pair	1 Pair	892 1F43

Max closing weight 25kg.

GATEMATE® Self-Closing Hinges without Legs



FINISH	SIZE (MM)	UNIT Qty	MIN. ORDER Qty	CODE
Black Composite/Polymer (A)	108 x 63.5	1 Pair	1 Pair	894 0V23
Aluminium/Black (B)	146 x 89	1 Pair	1 Pair	892 1F33

Max closing weight 25kg.

GATEMATE® Self-Closing Offset Hinges with Legs

DESC	FINISH	SIZE (MM)	UNIT Qty	MIN. ORDER Qty	CODE
Hinge (A)	Black Composite/ Polymer	108 x 110	1 Pair	1 Pair	894 1F83
Adjustable Hinge (B)	Black Composite/ Polymer	108 x 105	1 Pair	1 Pair	894 1A33
Adjustable Hinge + Round Post Adaptor	Black Composite/ Polymer		1 Pair	1 Pair	89A 1A53

Max closing weight 25kg.



SOFT CLOSE HINGE

GATEMATE® Heavy Duty Self-Closing Hinges

DESC	FINISH	SIZE (MM)	UNIT Qty	MIN. ORDER Qty	CODE
Hinge (A)	Black Composite/ Polymer	125 x 90	1 Pair	1 Pair	894 1F53
Adjustable Hinge (B)	Black Composite/ Polymer	125 x 178	1 Pair	1 Pair	894 1A73
Ornamental Hinge (C)	Black Steel	200	1 Pair	1 Pair	895 0F53

Max closing weight 60kg.

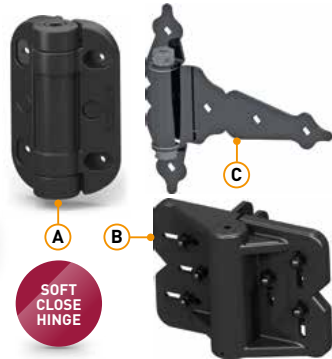

SOFT CLOSE HINGE

GATEMATE® Garage Door Bolt

FINISH	SIZE INS (MM)	MIN. ORDER Qty	CODE
Stainless Steel	18 (450)	1	896 1B83
Stainless Steel	24 (600)	1	896 1B93

Key lockable. Includes fixings.



Latches

GATEMATE® Child Safety Latch

DESC	FINISH	SIZE INS (MM)	MIN. ORDER Qty	OUTER CARTON Qty	CODE
Child Safety Latch	Black Polymer	10 (250)	1	5	898 1S23
Child Safety Latch	Black Polymer	20 (500)	1	5	898 1S33
Round Post Adapter	Black Polymer		1	5	89A 1F43



GATEMATE® Gravity Latch



DESC	FINISH	KEYED ALIKE	LOCK TYPE	MIN. ORDER Qty	OUTER CARTON Qty	CODE
Gravity Latch	Black Polymer	No	Single Locking	1	5	896 1S53
Gravity Latch	Black Polymer	No	Double Locking	1	5	896 1D53
Gravity Latch	Black Polymer	Yes	Single Locking	1	5	896 1S53KA
Gravity Latch	Black Polymer	Yes	Double Locking	1	5	896 1D53KA
Round Post Adapter	Black Polymer			1	5	89A 1F33

GATEMATE® Gravity Latch - Zinc Alloy



BEST SELLER ★ →

FINISH	KEYED ALIKE	LOCK TYPE	MIN. ORDER Qty	OUTER CARTON Qty	CODE
Black	No	Single Locking	1	5	897 1S53
Black	No	Double Locking	1	5	897 1D53
Black	Yes	Single Locking	1	5	897 1S53KA

GATEMATE® Pro Gravity Latch



FINISH	KEYED ALIKE	LOCK TYPE	MIN. ORDER Qty	OUTER CARTON Qty	CODE
Black Polymer	No	Double Locking	1	5	896 1D73
Black Polymer	Yes	Double Locking	1	5	896 1D73KA

GATEMATE® Magnetic Latch



FINISH	MIN. ORDER Qty	OUTER CARTON Qty	CODE
Black Polymer	1	5	898 1D43

GATEMATE® Magnetic Side Pull



FINISH	MIN. ORDER Qty	OUTER CARTON Qty	CODE
Black Polymer	1	5	898 0S13

GATEMATE® METAL GATES

GATEMATE® Easi-Fit Adjustable Gate Post System

GATEMATE®
Superior Gate Furniture

EASI-FIT ADJUSTABLE GATE POST SYSTEM

With unique anti-finger trap technology

- 3D adjustable pivot hinges available to prevent finger trapping - no other hinge system on the market has this benefit
- Height adjustable even after installation
- Unique high-load fixings; no need for welding, drilling or threading
- Patent Pending technology

Want a little more information?

View our
GATEMATE®
Easi-Fit
Adjustable Gate
Post brochure
online

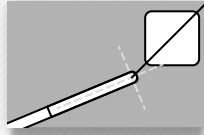

Positioning the gate so the edge is on the corner of the post ensures the gap between the two remains consistent; removing the danger of finger trapping bringing you in line with legislation.



GATEMATE® Easi-Fit Adjustable Gate Post System - Steel Post

FINISH	SIZE (MM)	MIN. ORDER Qty	CODE
Premium Black	2440 x 150 x 150	20	800 2443





GATEMATE® Easi-Fit Adjustable Gate Post System - Standard Hinge Set

FINISH	SIZE INS (MM)	PIN Ø (MM)	LOADING (KG)	MIN. ORDER Qty	CODE
Premium Black	12 (300)	19	200	1	801 0193

GATEMATE® Easi-Fit Adjustable Gate Post System - Top Pivot Hinge



FINISH	SIZE INS (MM)	DESC	LOADING (KG)	MIN. ORDER Qty	CODE
Premium Black	16 (400)	Right Hand	250	1	801 4003
Premium Black	16 (400)	Left Hand	250	1	801 4013

GATEMATE® Easi-Fit Adjustable Gate Post System - Bottom Pivot Hinge



FINISH	SIZE INS (MM)	DESC	LOADING (KG)	MIN. ORDER Qty	CODE
Premium Black	16 (400)	Right Hand	250	1	801 4023
Premium Black	16 (400)	Left Hand	250	1	801 4033

GATEMATE® Ascot Single Entrance Gate



FINISH	GATE SIZE H X W MM	TO SUIT OPENING SIZE MM	MIN. ORDER Qty	OUTER CARTON Qty	CODE
Premium Black	910*x815	900-1000	1	2	802 1003
Premium Black	910*x740	820-920	1	2	802 9003

*Including ground clearance of 50mm. Gates supplied with adjustable gate fixing kit.

TIP

Ensure to leave ground clearance of 50mm

GATEMATE® Windsor Bow Top Metal Gate



FINISH	GATE SIZE H X W MM	TO SUIT OPENING SIZE MM	MIN. ORDER Qty	CODE
Premium Black	1890*x815	900-1000	1	803 1003
Premium Black	1810*x740	820-920	1	803 9003

*Including ground clearance of 50mm. Gates supplied with adjustable gate fixing kit.

TIP

Ensure to leave ground clearance of 50mm

GATEMATE® Metal Gate Fixing Kit

FINISH	MIN. ORDER Qty	OUTER CARTON Qty	CODE
Epoxy Black	5	20	599 0003

Includes: latch bar, 2 x hinge mounts, receiver plate and fixings to suit



GATEMATE® Metal Gate Fixing Kit with Adjustable Gate Eyes

FINISH	MIN. ORDER Qty	OUTER CARTON Qty	CODE
Epoxy Black	1	5	801 0003

Gate kit includes: 2 x adjustable gate eyes, 2 x hinge mounts, padlockable latch assembly (padlock not included), receiving plate and fixings to suit



GATEMATE® Single Post for Iron Gates

FINISH	SIZE (MM)	MIN. ORDER Qty	CODE
Premium Black	1300 x 75 x 75	1	800 1303
Premium Black	2400 x 75 x 75	1	800 2403

Post supplied with plastic end caps and self drilling screws for gate fixing kits.



GATEMATE® SHELF AND HANDRAIL BRACKETS

GATEMATE® Folding Shelf Brackets



Easy to use folding multi-purpose bracket. Ideal for confined spaces.

FINISH	SIZE INS (MM)	MIN. ORDER Qty	CODE
Chrome	8 x 5 (200 x 135)	1	585 200C
Chrome	14 x 5 (350 x 135)	1	585 350C

GATEMATE® Handrail Brackets



FINISH	DISTANCE FROM WALL INS (MM)	UNIT Qty	MIN. ORDER Qty	CODE
BZP	2½ (65)	Pack of 2	5	833 0652
BZP	3 (75)	Pack of 2	5	833 0752
Epoxy Black	2½ (65)	Pack of 2	5	833 0653
White	2½ (65)	Pack of 2	5	833 0657
White	3 (75)	Pack of 2	5	833 0757

GATEMATE® CHAIN, WIRE & ROPE FITTINGS

GATEMATE® Straight Link Chain



FINISH	SIZE (MM)	LENGTH (M)	MIN. ORDER Qty	CODE
Galvanised	3 x 21	2	5	578 0031
Galvanised	4 x 26	2	5	578 0041
Galvanised	5 x 28	2	5	578 0051
Galvanised	6 x 42	2	5	578 0061

Size = thickness x inside of link

GATEMATE® Quick Repair Link



FINISH	SIZE (MM)	UNIT Qty	MIN. ORDER Qty	CODE
BZP	3	Pack of 2	5 Packs	591 0032
BZP	4	Pack of 2	5 Packs	591 0042
BZP	5	Pack of 2	5 Packs	591 0052
BZP	6	Pack of 2	5 Packs	591 0062
BZP	7	Pack of 1	5 Packs	591 0072
BZP	8	Pack of 1	5 Packs	591 0082
BZP	10	Pack of 1	5 Packs	591 0102

GATEMATE® Intermediate Fitting

FINISH	SIZE INS (MM)	SUITABLE FOR	UNIT Qty	MIN. ORDER Qty	CODE
Galvanised	3/8 (10)	4" posts	Pack of 2	5 Packs	580 0101



GATEMATE® End Fitting

FINISH	SIZE INS (MM)	SUITABLE FOR	UNIT Qty	MIN. ORDER Qty	CODE
Galvanised	3/8 (10)	4" posts	Pack of 2	5 Packs	581 0101



GATEMATE® Spring Hooks to Crue

FINISH	SIZE INS (MM)	UNIT Qty	MIN. ORDER Qty	CODE
BZP	2 (50)	Pack of 2	5 Packs	586 0502
BZP	3 (75)	Pack of 2	5 Packs	586 0752
BZP	3½ (88)	Pack of 2	5 Packs	586 0882
BZP	4 (100)	Pack of 2	5 Packs	586 1002



GATEMATE® Swivel Harness Snap Hook

FINISH	SIZE INS (MM)	MIN. ORDER Qty	CODE
Nickle Plated	3 x 3/4 (76 x 19)	5 Packs	588 0760



GATEMATE® Swivel Spring Hooks

FINISH	SIZE INS (MM)	UNIT Qty	MIN. ORDER Qty	CODE
BZP	2 (50)	Pack of 2	5 Packs	589 0502
BZP	3 (75)	Pack of 2	5 Packs	589 0752
BZP	4 (100)	Pack of 1	5 Packs	589 1002



GATEMATE® Carbine Hooks

FINISH	SIZE (MM)	UNIT Qty	MIN. ORDER Qty	CODE
BZP	5 x 50	Pack of 2	5 Packs	587 5052
BZP	6 x 60	Pack of 2	5 Packs	587 6062
BZP	7 x 70	Pack of 2	5 Packs	587 7072
BZP	8 x 80	Pack of 2	5 Packs	587 8082
BZP	10 x 100	Pack of 2	5 Packs	587 1002
BZP	11 x 120	Pack of 2	5 Packs	587 1212



GATEMATE® Dee Shackles



FINISH	GAUGE/ DIAMETER	UNIT Qty	MIN. ORDER Qty	CODE
BZP	6mm	Pack of 4	5 Packs	594 0062
BZP	8mm	Pack of 2	5 Packs	594 0082
BZP	10mm	Pack of 2	5 Packs	594 0102
BZP	12mm	Pack of 2	5 Packs	594 0122
BZP	16mm	Pack of 2	5 Packs	594 0162

GATEMATE® Ring on Heavy Duty Plate



FINISH	PLATE SIZE INS (MM)	MIN. ORDER Qty	CODE
Galvanised	4 x 2 (100 x 50)	5	546 1501

GATEMATE® Ring on Plate



FINISH	PLATE SIZE INS (MM)	MIN. ORDER Qty	OUTER CARTON Qty	CODE
Galvanised	2 x 2 (50 x 50)	5	40	584 0501

GATEMATE® Hooks on Plate



FINISH	PLATE SIZE INS (MM)	UNIT Qty	MIN. ORDER Qty	CODE
Galvanised	2 x 2 (50 x 50)	Pack of 2	5 Packs	582 0501

GATEMATE® Staples on Plate



FINISH	SIZE INS (MM)	UNIT Qty	MIN. ORDER Qty	OUTER CARTON Qty	CODE
Galvanised	2 x 2 (50 x 50)	Pack of 2	5 Packs	40 Packs	583 0501

GATEMATE® Bucket Clip on Plate

FINISH	SIZE INS (MM)	MIN. ORDER Qty	CODE
Galvanised	2 x 2 (50 x 50)	5	584 0001



GATEMATE® Screw Hooks

FINISH	SIZE INS (MM)	UNIT Qty	MIN. ORDER Qty	CODE
BZP	3 (75)	Pack of 2	5 Packs	592 0752



GATEMATE® Manger Ring on Eyebolt

FINISH	SIZE INS (MM)	MIN. ORDER Qty	CODE
BZP	3 x 8 (75 x 200)	5	585 0752



GATEMATE® Tying Wire - ½kg Coil

FINISH	GAUGE (MM)	MIN. ORDER Qty	CODE
Galvanised	1.6	5	542 0011
Green PVC	2/1.4	5	542 0029
Black PVC	2/1.4	5	542 0039



GATEMATE® Wire Rope Grips

FINISH	GAUGE (MM)	UNIT Qty	MIN. ORDER Qty	CODE
BZP	3	Pack of 4	5 Packs	593 0032
BZP	5	Pack of 4	5 Packs	593 0052
BZP	6	Pack of 4	5 Packs	593 0062
BZP	8	Pack of 2	5 Packs	593 0082
BZP	10	Pack of 2	5 Packs	593 0102
BZP	12	Pack of 2	5 Packs	593 0122
BZP	16	Pack of 2	5 Packs	593 0162



GATEMATE® Barrel Strainers



FINISH	SIZE INS (MM)	UNIT Qty	MIN. ORDER Qty	CODE
BZP	¼ (6)	Pack of 2	5 Packs	590 0062
BZP	⅜ (8)	Pack of 2	5 Packs	590 0082
BZP	⅝ (10)	Pack of 2	5 Packs	590 0102
BZP	½ (12)	Pack of 2	5 Packs	590 0122

GATEMATE® Multi Function Rope on Winder



FINISH	LENGTH (M)	GAUGE (MM)	MIN. ORDER Qty	CODE
White	15	8	5	579 1380
White	20	4	5	579 2040
White	20	6	5	579 2260

GATEMATE® Polypropylene Rope on Winder



FINISH	LENGTH (M)	GAUGE (MM)	MIN. ORDER Qty	CODE
Blue	15	8	5	579 1480
Blue	20	6	5	579 2160
Orange	15	8	5	579 1580
Orange	20	6	5	579 2060

FENCEMATE®
Superior Fencing Accessories

**HAVE YOU SEEN
OUR COARSE
AGGREGATE POST
CONCRETE?**

Two step, fast setting post concrete designed to make your life easier!

All you need is water and it sets in 5 – 10 minutes.

Ask your stockist for more details



GATEMATE® TRAILER FITTINGS

GATEMATE® Tailboard Hook to Bolt

FINISH	SIZE INS (MM)	UNIT Qty	MIN. ORDER Qty	CODE
Self Colour	5/16 (8)	Pack of 4	5 Packs	835 0084



GATEMATE® Hinge Pins to Bolt

FINISH	SIZE INS (MM)	UNIT Qty	MIN. ORDER Qty	CODE
Self Colour	1/2 (12)	Pack of 2	5 Packs	836 0124



GATEMATE® Hinge Pins to Weld

FINISH	SIZE INS (MM)	UNIT Qty	MIN. ORDER Qty	CODE
Self Colour	1/2 (12)	Pack of 2	5 Packs	836 1124



GATEMATE® Short Hinges

FINISH	SIZE INS (MM)	EYE Ø INS (MM)	UNIT Qty	MIN. ORDER Qty	CODE
Self Colour	6 x 1½ (150 x 40)	½ (12)	Pack of 2	5 Packs	837 0124
Self Colour	6 x 1 (150 x 25)	½ (12)	Pack of 2	5 Packs	837 1124



GATEMATE® Spade Hinges to Weld

FINISH	SIZE INS (MM)	EYE Ø INS (MM)	UNIT Qty	MIN. ORDER Qty	CODE
Self Colour	3 x 1¾ (75 x 44)	½ (12)	Pack of 2	5 Packs	845 0124



GATEMATE® Cotter Pins & Chain

FINISH	SIZE INS (MM)	UNIT Qty	MIN. ORDER Qty	CODE
BZP	1½ (38)	Pack of 2	5 Packs	840 0382



GATEMATE® Linch Pins

FINISH	SIZE INS (MM)	DESC	UNIT Qty	MIN. ORDER Qty	CODE
BZP	¼ (6)	Small	Pack of 2	5 Packs	842 0062
BZP	⅝ (8)	Medium	Pack of 2	5 Packs	842 0082



GATEMATE® Drop Catch to Bolt

FINISH	SIZE INS (MM)	DESC	UNIT Qty	MIN. ORDER Qty	CODE
BZP	1 (25)	Short	Pack of 2	5 Packs	838 0252
BZP	3 (75)	Long	Pack of 2	5 Packs	838 0752



GATEMATE® FENCING ACCESSORIES

GATEMATE® Rabbit Netting Pegs

FINISH	SIZE INS (MM)	UNIT Qty	MIN. ORDER Qty	CODE
Galvanised	12 (300)	Pack of 5	5 Packs	830 3001



GATEMATE® Arris Rail Repair Bracket

FINISH	SUITABLE FOR	UNIT Qty	MIN. ORDER Qty	CODE
Pre-Galvanised	3" arris rail	Pack of 4	5 Packs	831 0757
Epoxy Brown	3" arris rail	Pack of 4	5 Packs	831 0759



GATEMATE® Panel Fixing Clips

FINISH	SIZE (MM)	UNIT Qty	MIN. ORDER Qty	CODE
Pre-Galvanised	35 x 35	Pack of 4	5 Packs	832 0357
Pre-Galvanised	45 x 50	Pack of 4	5 Packs	832 0457
Pre-Galvanised	50 x 50	Pack of 4	5 Packs	832 0507



GATEMATE® Screw-In Panel Clips

FINISH	SIZE MM	UNIT Qty	MIN. ORDER Qty	CODE
Galvanised	40 x 40 x 30	Pack of 4	5 Packs	832 0401



GATEMATE® Balustrade Brackets

FINISH	SIZE MM	UNIT Qty	MIN. ORDER Qty	CODE
BZP	40 x 40 x 30	Pack of 10	5 Packs	832 0302



GATEMATE® Corner Braces

FINISH	SIZE INS (MM)	UNIT Qty	MIN. ORDER Qty	CODE
BZP/YP	1 (25)	Pack of 10	5 Packs	531 0258
BZP/YP	1½ (38)	Pack of 10	5 Packs	531 0388
BZP/YP	2 (50)	Pack of 10	5 Packs	531 0508
BZP/YP	2½ (65)	Pack of 5	5 Packs	531 0658
BZP/YP	3 (75)	Pack of 5	5 Packs	531 0758
BZP/YP	4 (100)	Pack of 5	5 Packs	531 1008
BZP/YP	6 (150)	Pack of 5	5 Packs	531 1508

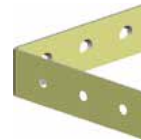

GATEMATE® Corner Plates

FINISH	SIZE INS (MM)	UNIT Qty	MIN. ORDER Qty	CODE
BZP/YP	2 (50)	Pack of 10	5 Packs	535 0508
BZP/YP	2½ (65)	Pack of 5	5 Packs	535 0658
BZP/YP	3 (75)	Pack of 5	5 Packs	535 0758
BZP/YP	4 (100)	Pack of 5	5 Packs	535 1008
BZP/YP	5 (125)	Pack of 5	5 Packs	535 1258
BZP/YP	6 (150)	Pack of 5	5 Packs	535 1508

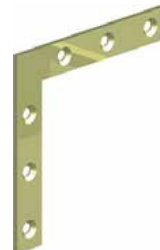

GATEMATE® Tee Plates



FINISH	SIZE INS (MM)	UNIT Qty	MIN. ORDER Qty	CODE
BZP/YP	3 (75)	Pack of 5	5 Packs	536 0758
BZP/YP	4 (100)	Pack of 5	5 Packs	536 1008

GATEMATE® Mending Plates



FINISH	SIZE INS (MM)	UNIT Qty	MIN. ORDER Qty	CODE
BZP/YP	3 (75)	Pack of 5	5 Packs	537 0758
BZP/YP	4 (100)	Pack of 5	5 Packs	537 1008
BZP/YP	5 (125)	Pack of 5	5 Packs	537 1258

GATEMATE® Table Stretcher Plates



FINISH	SIZE INS (MM)	UNIT Qty	MIN. ORDER Qty	CODE
BZP/YP	1½ (38)	Pack of 10	5 Packs	538 0388

GATEMATE®
Superior Gate Furniture

**ALL OUR
PRE-PACKED
GATE FURNITURE
COMES WITH
HIGH PERFORMANCE
RUSPERT COATED
WOODSCREWS
AS STANDARD**

**PREMIUM
RUSPERT®
COATING**



With Premium Ruspert® Coating

- ✓ High performance treatment designed to withstand corrosion
- ✓ Comprised of three layers

Baked ceramic surface

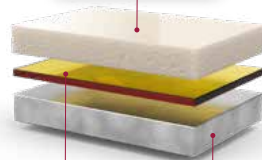

Chemical conversion film

Metallic zinc layer

A	
Adjustable Band & Hook on Plate	33,48,51
Adjustable Double Strap Hinge Set	18,52
Adjustable Gate Eye	25
Animal Bolt	43
Animal Safety Self Locking Catch Kit	22
Arris Rail Repair Bracket	70
Ascot Single Entrance Gate	62
Auto Gate Catch	38-39
B	
Balustrade Brackets	71
Band & Hook Hinges	32-33,48,51,54
Barrel Strainers	68
Blank Key for Premium Long Throw Lock	8
Bow Handle Bolts	45
Braced Adjustable Band & Hook on Plate	33
Brass Padlock	12
Brenton Padbolt	42-43,50,53
Bucket Clip on Plate	67
Butt Hinge	34-35,49
C	
Cabin Hooks	39-40,50,53,56
Cane Bolt	44
Carbine Hooks	65
Central Closing Catch	23
Chain Bolt	45
Child Safety Latch	59
Corner Braces	71
Corner Plates	71
Cotter Pins & Chain	70
Cranked Band & Hook on Plate	32,48,51
Curve Rail Hinges Kit	32,51
D	
D Bracket	24
Dee Shackles	66
Disc Padlock	13
Door Knob	15,57
Door-Gate Stop	41
Double Field Gate Fastener Set	20,52
Double Gate Drop Bolt - Zedlock®	11
Double Strap Hinge Set	16-18,52
Drop Catch to Bolt	70
E	
Easi-Fit Adjustable Gate Post System	61,62
Easy-Close Auto Gate Catch	38
End Fitting	65
Escutcheon for Euro Profile Long Throw Lock	6
Euro Profile Long Throw Lock	5-6
F	
Fleur De Leys Tee Hinges	54
Folding Shelf Brackets	64
Foot Bolt	45
G	
Garage Door Bolt	44,50,53,59
Gate Claw - Zedlock®	11
Gate Return Spring	40
Gate Signs	47
Gates	62
Gravity Latch	60
H	
Handrail Brackets	64
Hasp & Staples	46-47
Heavy Cross Pattern Door Bolt	43
Heavy Reversible Hinges	34,51
High Visibility Reflectors	47
Hinge Pins	69
Hinge Sets	16-19,52
Hole Cutter - Zedlock®	11
Hooks on Plate	66
Hunting Type Catch Kit	22-23
I	
Intermediate Fitting	65
K	
Kenham Gate Catch	39
Kick Over Stable Latch	40
L	
Laminated Steel Padlock	13
Linch Pins	70
Locking Bars to Swivel	46
Locking Garage Door Bolt	44,50
Long Throw Locks	5-7,9-10
M	
Magnetic Latch	60
Magnetic Side Pull	60
Manger Ring on Eyebolt	67
Medium Strap Hinges	30
Mending Plates	72
Metal Gate Fixing Kit	63
Monkey Tail Bolt	45
Morticed Striker - Zedlock®	11
Multi-Lever Key Blanks - Zedlock®	10
N	
Necked Tower Bolt	41
New Zealand Fasteners	21
Northumberland Fastener	21

O		Spring Hooks.....	65
Offset Tee Hinges.....	30	Spring Loaded Wheel.....	25
Ornamental Casement Stay.....	57	Spring-Loaded Bolts.....	43
Ornamental Door Studs.....	57	Staple on Elongated Plate.....	25
Ornamental Fleur De Leys Handles.....	56	Staples.....	24
Ornamental Heavy Duty Drop Bolts.....	56	Staples on Plate.....	66
Ornamental Hinges.....	54-55	Straight Band & Hook on Plate.....	31,48,54
Ornamental Letter Plate.....	57	Straight Link Chain.....	64
Ornamental Numerals.....	57	Suffolk Latch.....	36,49,53,55
Ornamental Straight Door Bolts.....	56	Surface Mounted Keep & Kit - Zedlock®.....	11
Oval Padbolt.....	41	Swivel Hooks.....	65
P		T	
Padlock Eyes.....	14	Table Stretcher Plates.....	72
Padlock Protector.....	14	Tailboard Hook to Bolt.....	69
Padlocks.....	12-13	Tee Hinges.....	27-30,48,50,54
Panel Fixing Clips.....	71	Tee Plates.....	72
Pedestrian Gate Kit.....	26	Throwover Loop.....	25
Premium Long Throw Lock.....	7	Tower Bolt.....	41
Pull Handles.....	6,8,56	Turn Buttons Cast.....	40
Q		Twisted Ring Gate Latch.....	38
Quick Repair Link.....	64	Tying Wire.....	67
R		U	
Rabbit Netting Pegs.....	70	Unsprung Gate Hinges.....	58
Rail Brackets.....	24	V	
Rimsashlock.....	15	Vertical Pattern Hasp & Staple.....	46
Ring Gate Latch.....	37-38,49,53,55	W	
Ring Handle Only.....	37,55	Windsor Bow Top Metal Gate.....	62
Ring on Plate.....	66	Wire Pattern Hasp & Staple.....	47
Rising Hinge Set.....	18-19	Wire Rope Grips.....	67
Rope on Winder.....	68	Z	
S		Zedlock®.....	9-11
Safety Hook & Eye.....	25		
Safety Pattern Hasp & Staple.....	46		
Screw Hooks.....	67		
Screw-In Panel Clips.....	71		
Self-Closing High Performance Hinges.....	58-59		
Self-Closing/Rising Hinge Set.....	18-19		
Self-Locking Catch Kit.....	21-22		
Shed Security Bar.....	14		
Shoot Bolt.....	23		
Short Hinges.....	69		
Side Gate Kit.....	26		
Single Post for Iron Gates.....	63		
Slip Rail Bracket.....	24		
Spade Drill for Long Throw Locks.....	8		
Spade Hinges to Weld.....	69		
Spare Parts for Euro Profile Long Throw Lock.....	7		
Spring Fastener Set.....	20-21,52		

GATEMATE®

SUPERIOR GATE FURNITURE

Authorised Distributor



Printed in the UK using vegetable based inks.
Printed on FSC certified paper from well managed Forests using mix sources.